

Round cylinders DSNU

FESTO

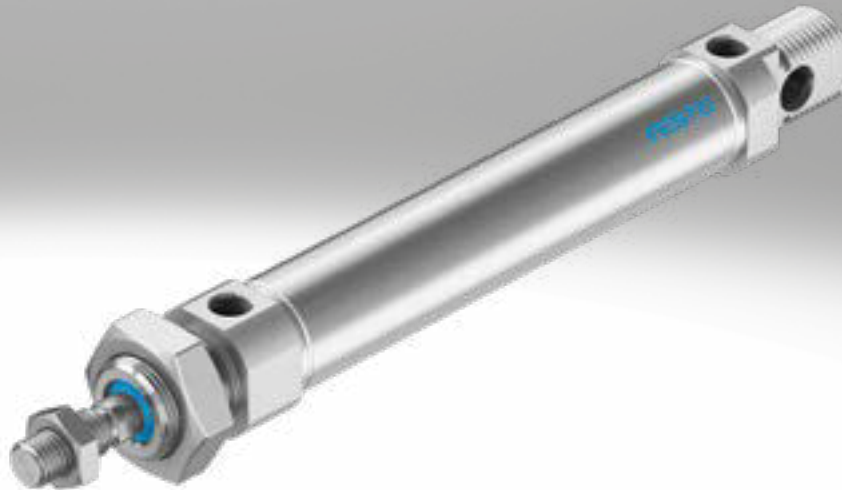

Festo Core Range
Solves the majority of your automation tasks

With the Festo Core Range, we have selected the most important products and functions from our broad product catalogue, and added the quickest delivery.

Worldwide: Quickest delivery – wherever, whenever
Simply good: Expected high Festo quality
Fast: Easy and fast to select

The Core Range offers you the best value for your automation tasks.

Just look
for the
star!

Key features

At a glance

DSNU-8 ... 63

- Stainless steel piston rod
- Good running performance and long service life
- Piston rod with male and female thread

- Extensive range of accessories makes it possible to install the cylinder virtually anywhere

DSNU-8 ... 25



- The basic versions conform to ISO 6432, variants are based on these standards

Wide choice of variants

DSNU	DSNU-...-MA	DSNU-...-MQ	DSNU-...-MH
<ul style="list-style-type: none"> • Piston \varnothing 8 ... 63 mm • Cylinder barrel made of stainless steel • Bearing and end caps made of wrought aluminium alloy 	<ul style="list-style-type: none"> • Piston \varnothing 8 ... 63 mm • Cylinder barrel made of stainless steel • Bearing cap with threaded flange • Short end cap with axial supply port 	<ul style="list-style-type: none"> • Piston \varnothing 8 ... 63 mm • Cylinder barrel made of stainless steel • Bearing cap with threaded flange • Short end cap with lateral supply port 	<ul style="list-style-type: none"> • Piston \varnothing 8 ... 63 mm • Cylinder barrel made of stainless steel • Direct mounting on bearing cap • Short end cap with lateral supply port



DSNU-...-KP

- Piston \varnothing 8 ... 63 mm
- Cylinder barrel made of stainless steel
- With clamping unit



DSNU-...-Q











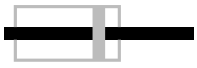

- Piston \varnothing 12 ... 63 mm
- Cylinder barrel made of stainless steel
- With square piston rod



Cushioning types

	Cushioning P	Cushioning PPS	Cushioning PPV
Mode of operation	<ul style="list-style-type: none"> • The drive is equipped with flexible polymer end-position cushioning 	<ul style="list-style-type: none"> • The drive is equipped with self-adjusting end-position cushioning 	<ul style="list-style-type: none"> • The drive is equipped with adjustable end-position cushioning
Application	<ul style="list-style-type: none"> • Small loads • Low speeds • Low impact energies 	<ul style="list-style-type: none"> • Small to medium loads • Low to medium speeds • Medium impact energies 	<ul style="list-style-type: none"> • Medium to high loads • High speeds • High impact energies
Advantages	<ul style="list-style-type: none"> • No adjustment required • Saves time 	<ul style="list-style-type: none"> • No adjustment required • Saves time • Powerful 	<ul style="list-style-type: none"> • Very powerful

Key features

Further variants Symbol	Key features	Description
	S2 Through piston rod	For working at both ends with the same force in the forward and return stroke, for attaching external stops
	S6 Heat-resistant seals	Temperature resistance up to max. 120°C
	S10 Constant motion at low piston speeds	Suitable for very slow and constant (slow speed) and stick-slip-free movements. With very low break-away pressure compared with the standard (low friction).
	L Low friction	<ul style="list-style-type: none"> • Break-away pressure: low • Dynamic response: Suitable for very fast movements, especially at low operating pressures Application example: Very dynamic movements with no standstill
	K2 Extended male piston rod thread	–
	K3 Female piston rod thread	–
	K5 Custom piston rod thread	Metric standard thread to ISO
	K6 Shortened male piston rod thread	–
	K8 Extended piston rod	–
	R3 High corrosion protection	All external cylinder surfaces comply with corrosion resistance class CRC 3 to Festo standard 940070. The piston rod is made from corrosion- and acid-resistant steel
	R8 Dust protection (wiper seal) (32 ... 63 mm)	The cylinder has a hard-chrome-plated piston rod and a hard wiper seal, which protects against dry, dusty media
	A1 Scraper variant (12 ... 63 mm)	Increased chemical resistance: For longer service life, e.g. when using cooling lubricants.
	A6 Metal scraper (32 ... 63 mm)	The cylinder has a hard-chrome-plated piston rod and metal scraper, which scrapes off hard particles (e.g. welding spatter) that stick to the piston rod. For use in welding systems, for example
	F1A Recommended for production plants for manufacturing lithium-ion batteries	Cylinders free of copper, zinc and nickel ($\leq 1\%$)

For manufacturing lithium-ion batteries

DSNU-...-F1A

Recommended for production plants for manufacturing lithium-ion batteries. Metals with copper, zinc or nickel as the main constituent are excluded from use. Exceptions are nickel in steels, chemically nickel-plated surfaces, printed circuit boards, cables, electrical plug connectors and coils.

Accessories

Your Festo contact partner can provide information about which accessories are suitable for manufacturing lithium-ion batteries.

Longer service life with protective bellows kit DADB



The bellows protects the piston rod, the seal and the bearing from the effects of a wide range of media, which has a positive impact on the service life of these components.

The bellows kit is a leak-free system. To prevent unwanted media from being drawn in, the supply and exhaust air for the kit must be ducted via a pressure compensation hole in the connection part [1].

The kit protects the piston rod, seal and bearing against a wide variety of media, for example:

- Dust
- Grease
- Chippings
- Fuel
- Oil

Product range overview

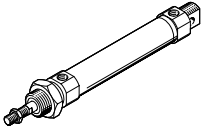
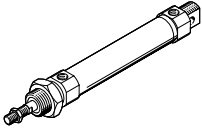
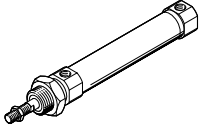
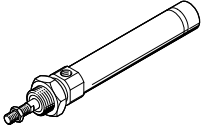
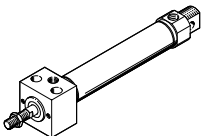
Function	Design	Piston \varnothing [mm]	Stroke [mm]	Variable stroke ¹⁾ [mm]	Piston rod						
					Through S2	Extended K8	Male thread			Female thread K3	
							Extended K2	Shortened K6	Custom thread K5		
Double-acting	DSNU-... – Cylinder barrel made of stainless steel										
		8, 10	10, 15, 20, 25, 30, 35, 40, 50,	1 ... 100							
		12, 16	60, 70, 80, 100, 125, 150, 160,	1 ... 200							
		20	200, 250, 300, 320, 400, 500	1 ... 320							
		25		1 ... 500	■	■	■	■	■	■	■
		32, 40, 50, 63	25, 40, 50, 80, 100, 125, 160, 200, 250, 320	1 ... 500					From \varnothing 25	From \varnothing 20	
	DSNU-Q-... – Protected against rotation										
		12, 16	–	1 ... 160							
		20	–	1 ... 200							
		25	–	1 ... 250	■	■	■	■	■	■	■
		32	–	1 ... 300					From \varnothing 25	From \varnothing 20	
		40, 50	–	1 ... 400							
		63	–	1 ... 500							
	DSNU-MQ-... – Lateral supply port, short end cap										
		8, 10	–	1 ... 100							
		12, 16	–	1 ... 200							
		20	–	1 ... 320	–	■	■	■	■	■	■
		25	–	1 ... 500							
		32, 40, 50, 63	–	1 ... 500							
	DSNU-MA-... – Axial supply port, short end cap										
	8, 10	–	1 ... 100								
	12, 16	–	1 ... 200								
	20	–	1 ... 320								
	25	–	1 ... 500	–	■	■	■	■	■	■	
	32, 40, 50	–	1 ... 500								
	63	–	1 ... 500								
DSNU-MH-... – Direct mounting											
	8, 10	–	1 ... 100								
	12, 16	–	1 ... 200								
	20	–	1 ... 320	■	■	■	■	■	■	■	
	25	–	1 ... 500								
	32, 40, 50	–	1 ... 500								
	63	–	1 ... 500								

1) Cylinders with position sensing require a minimum stroke of 10 mm to ensure reliable sensing

Product range overview

Piston \varnothing	Cushioning			Position sensing	Clamping unit	Heat-resistant seal	Slow speed (constant motion)	Low friction	Corrosion protection	Dust protection (wiper seal)	Wiper seal variant	Metal scraper	For battery production	→ Page/ Internet	
	Fixed	Adjustable	Self-adjusting												
P	PPV ²⁾	PPS	A	KP	S6	S10	L	R3	R8	A1	A6	F1A			
DSNU-... – Cylinder barrel made of stainless steel															
8 ... 63	■	■ From \varnothing 16	■ From \varnothing 16	■	■	■	■ From \varnothing 12	■	■	■ From \varnothing 12	■ From \varnothing 32	■ From \varnothing 12	■ From \varnothing 32	■ Up to \varnothing 40	9
DSNU-Q-... – Protected against rotation															
12 ... 63	■ \varnothing 12 and From \varnothing 32	■ From \varnothing 16	–	■	■	■ From \varnothing 32	–	–	■ From \varnothing 16	–	–	–	–	–	46
DSNU-MQ-... – Lateral supply port															
8 ... 63	■	■ From \varnothing 16	■ From \varnothing 16	■	■	■	–	–	■	■ From \varnothing 32	■	■ From \varnothing 32	■ Up to \varnothing 40	9	
DSNU-MA-... – Axial supply port															
8 ... 63	■ From \varnothing 32	–	–	■	■	■	–	–	■	–	■	■	■ Up to \varnothing 40	9	
DSNU-MH-... – Direct mounting															
8 ... 63	■	■ From \varnothing 32	–	■	–	■	–	–	■	–	–	–	–	9	

2) In the modular product system from \varnothing 12 mm

Peripherals overview

DSNU-...

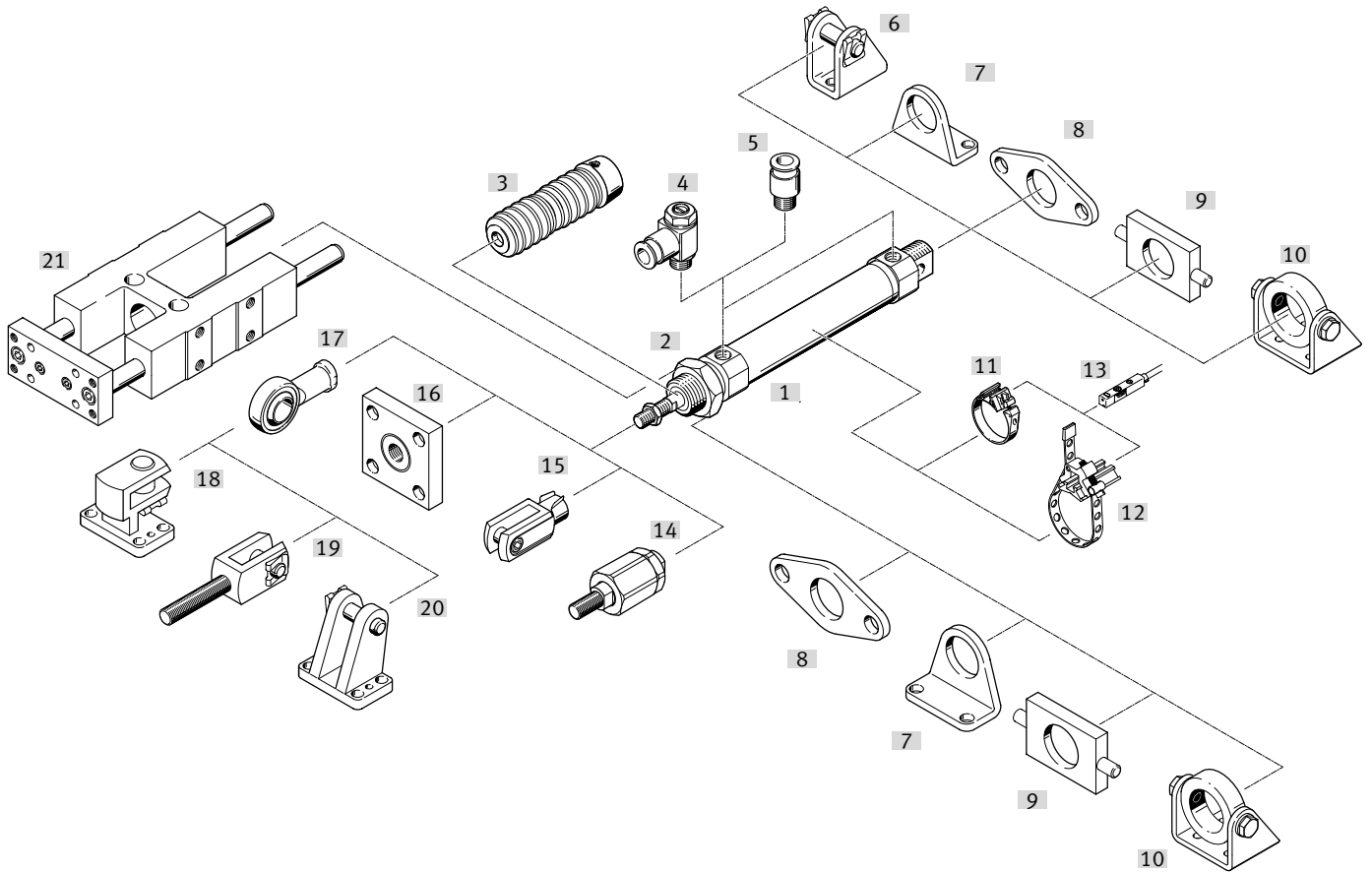

Peripherals overview

Mounting attachments and accessories		Piston ø	DSNU				DSNU-Q		→ Page/ Internet
			MA	MQ	MH	KP			
[1]	Round cylinder DSNU								
[2]	Hex nut MSK	16 ... 25	■	■	■	■	■	■	60
[3]	Bellows kit ²⁾ DADB	12 ... 63	■	■	■	–	–	–	62
[4]	One-way flow control valve GRLA/GRLZ	8 ... 63	■	■	■	■	■	■	70
[5]	Push-in fitting QS	8 ... 63	■	■	■	■	■	■	qs
[6]	Clevis foot LBN/CRLBN	8 ... 63	■	–	–	–	■	■	59
[7]	Foot mounting HBN/CRHBN/CRH	8 ... 63	■	■	■	–	■	■	54
[8]	Flange mounting FBN/CRFBN/CRFV	8 ... 63	■	■	■	–	■	■	56
[9]	Swivel mounting ¹⁾ WBN	8 ... 63	■	■	■	–	■	■	58
[10]	Swivel mounting ¹⁾ SBN	20 ... 63	■	■	■	–	■ ø 20 ... 50	■	58
[11]	Mounting kit SMBR	8 ... 63	■	■	■	■	■	■	68
[12]	Mounting kit SMBR...S6	8 ... 63	■	■	■	■	■	■	68
[13]	Proximity switch SMT/CRSMT/SDBT	8 ... 63	■	■	■	■	■	■	68
	Position transmitter SDAS/SDAT/SMAT	8 ... 63	■	■	■	■	■	■	69
[14]	Self-aligning rod coupler FK/CRFK/DARP	8 ... 63	■	■	■	■	■	■	60
[15]	Rod clevis SG/CRSG	8 ... 63	■	■	■	■	■	■	60
[16]	Coupling piece KSG/KSZ	12 ... 63	■	■	■	■	■	■	60
[17]	Rod eye SGS/CRSGS	8 ... 63	■	■	■	■	■	■	60
[18]	Right-angle clevis foot LQG	32 ... 63	■	■	■	■	■	■	59
[19]	Rod clevis SGA	32 ... 63	■	■	■	■	■	■	60
[20]	Clevis foot LBG	32 ... 63	■	■	■	■	■	■	61
[21]	Guide unit FEN	8 ... 25	■	■	■	–	–	–	61

 **Note**

- 1) Cannot be used on the bearing cap in combination with bellows kit DADB.
- 2) The bellows kit protects the cylinder (piston rod, seal and bearings) against a wide range of media and thus prevents premature wear. It can only be used in combination with an extended piston rod (K8)

Type codes

DSNU-...

001	Series	
DSNU	Round cylinder, double-acting, based on ISO 6432	

002	Piston diameter	
8	8	
10	10	
12	12	
16	16	
20	20	
25	25	
32	32	
40	40	
50	50	
63	63	

003	Stroke	
...	1 ... 500	

004	Cushioning	
P	Elastic cushioning rings/plates on both sides	
PPS	Pneumatic cushioning, self-adjusting at both ends	
PPV	Pneumatic cushioning, adjustable at both ends	

005	Position sensing	
A	For proximity sensor	

006	Special material properties	
	None	
F1A	Recommended for production facilities for the manufacture of lithium-ion batteries (Cu<=1%, Zn<=1%, Ni<=1%)	

007	Cylinder end cap	
	Standard	
MA	Axial air connection, end cap	
MH	Direct mounting, bearing cap	
MQ	Transverse supply port, end cap	

008	Protection against rotation	
Q	Square piston rod	
	None	

009	Piston rod type	
	At one end	
S2	Through piston rod	

010	Piston rod thread extension	
	None	
...K2	1 ... 70 mm	

011	K6 - Shortened male piston rod thread	
	None	
K6	1 ... 10 mm	

012	Piston rod thread type	
	Male thread	
K3	Female thread	

013	Custom thread	
"M10"K5	M10	
"M12"K5	M12	
"M16"K5	M16	

014	Piston rod extension	
	None	
...K8	1 ... 500 mm	

015	Clamping unit	
	None	
KP	attached	

016	Temperature range	
	Standard	
S6	Heat-resistant seals max. 120 °C	

017	Constant motion	
	Standard	
S10	Uniform, slow movement	

018	Corrosion protection	
	Standard	
R3	High corrosion protection	

019	Scraper variant	
	Standard	
R8	Dust protection	
A6	Metal scraper	

020	EU certification	
	None	
EX4	II 2GD	

Datasheet

P cushioning

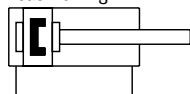

-  Diameter
8 ... 25 mm
ISO 6432

PPV cushioning

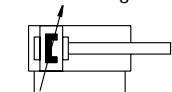

-  Diameter
32 ... 63 mm

PPS cushioning

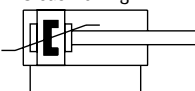

-  Stroke length
1 ... 500 mm,
longer strokes on request



General technical data											
Piston \varnothing	8	10	12	16	20	25	32	40	50	63	
Conforms to standard	ISO 6432						-				
Pneumatic connection	M5	M5	M5	M5	G1/8	G1/8	G1/8	G1/4	G1/4	G3/8	
Piston rod thread	M4	M4	M6	M6	M8	M10x1.25	M10x1.25	M12x1.25	M16x1.5	M16x1.5	
Stroke ¹⁾ [mm]	1 ... 100		1 ... 200		1 ... 320	1 ... 500					
Design	Piston/piston rod/cylinder barrel										
Cushioning											
DSNU-...-P	Elastic cushioning rings/pads at both ends										
DSNU-...-PPV	-		Cushioning, adjustable at both ends								
DSNU-...-PPS	-		Cushioning, self-adjusting at both ends								
Cushioning length											
DSNU-...-PPV [mm]	-		9	12	15	17	14	18	20	21	
DSNU-...-PPS [mm]	-		12	15	17	14	18	20	21		
Position sensing	Via proximity switch										
Type of mounting	Direct mounting (variant MH only)										
	With accessories										
Mounting position	Any										

1) Cylinders with position sensing require a minimum stroke of 10 mm to ensure reliable sensing.
Longer strokes on request

Datasheet

Operating and environmental conditions											
Piston ø		8	10	12	16	20	25	32	40	50	63
Operating medium	Compressed air to ISO 8573-1:2010 [7:4:4]										
Note on the operating/pilot medium	Lubricated operation possible (in which case lubricated operation will always be required)										
Operating pressure											
DSNU-...	[MPa]	0.15 ... 1 ¹⁾			0.1 ... 1						
	[bar]	1.5 ... 10 ¹⁾			1 ... 10						
DSNU-...-S10	[MPa]	–		0.05 ... 1	0.03 ... 1			0.02 ... 1			
	[bar]	–		0.5 ... 10	0.3 ... 10			0.2 ... 10			
DSNU-...-L	[MPa]	0.06 ... 1			0.05 ... 1		0.04 ... 1		0.02 ... 1		
	[bar]	0.6 ... 10			0.5 ... 10		0.4 ... 10		0.2 ... 10		
DSNU-...-A6	[MPa]	–							0.2 ... 1		
	[bar]	–							2 ... 10		
Ambient temperature ²⁾											
DSNU-...	[°C]	–20 ... +80									
DSNU-...-S6	[°C]	0 ... +120									
DSNU-...-S10/L	[°C]	+5 ... +80									
DSNU-...-R3	[°C]	–20 ... +80									
DSNU-...-A1	[°C]	0 ... +80									
DSNU-...-S6-A6	[°C]	–							0 ... +120		
Corrosion resistance class CRC ³⁾											
DSNU-...		2									
DSNU-...-R3		3									
DSNU-...-F1A		0									
DSNU-...-P		See certificate							–		
DSNU-...-PPV		See certificate							–		

1) For DSNU-12...-PPV (pneumatic cushioning adjustable at both ends): 0.2 ... 1 MPa (2 ... 10 bar)

2) Note operating range of proximity switches

3) Corrosion resistance class CRC 0 to Festo standard FN 940070

No corrosion stress. Applies to small, visually unimportant standards-based parts such as threaded pins, circlips and clamping sleeves which are usually only available on the market in a phosphated or burnished version (and possibly oiled) as well as to ball bearings (for components < CRC 3) and plain bearings.

Corrosion resistance class CRC 2 to Festo standard FN 940070

Moderate corrosion stress. Indoor applications in which condensation can occur. External visible parts with primarily decorative surface requirements which are in direct contact with a normal industrial environment.

Corrosion resistance class CRC 3 to Festo standard FN 940070

High corrosion stress. Outdoor exposure under moderate corrosive conditions. Externally visible parts with primarily functional surface requirements which are in direct contact with a normal industrial environment.

ATEX ¹⁾	
ATEX category for gas	II 2G
Type of ignition protection for gas	Ex h IIC T4 Gb
ATEX category for dust	II 2D
Type of ignition protection for dust	Ex h IIIC T120°C Db
Explosion-proof ambient temperature	–20°C ≤ Ta ≤ +60°C
CE marking (see declaration of conformity)	To EU Explosion Protection Directive (ATEX)
UKCA marking (see declaration of conformity)	To UK EX instructions
Explosion protection certification outside the EU	EPL Db (GB)
	EPL Gb (GB)

1) Note the ATEX certification of the accessories.

Weights [g]										
Piston ø	8	10	12	16	20	25	32	40	50	63
Product weight with 0 mm stroke	34.6	37.3	75	89.9	186.8	238	370.5	661	1087	1445
Additional weight per 10 mm stroke	2.4	2.7	4	4.6	7.2	11	15.5	24	40	44
Moving mass with 0 mm stroke	7.5	8.5	18.5	23	44	71	121	230	413	459
Moving mass per 10 mm stroke	1	1	2	2	4	6	9	16	25	25

Datasheet

Speed [mm/s] ¹⁾							
Piston \varnothing	16	20	25	32	40	50	63
Speed with stick-slip-free operation, S10 horizontal, without load, at 0.6 MPa (6 bar)	10 ... 100			8 ... 100			5 ... 100

1) Measurements of less than 1 mm/s were not conducted

Forces [N] and impact energy [J]										
Piston \varnothing	8	10	12	16	20	25	32	40	50	63
Theoretical force at 0.6 MPa (6 bar), advancing	30	47	68	121	189	295	483	753	1178	1870
Theoretical force at 0.6 MPa (6 bar), retracting	23	40	51	104	158	247	415	633	990	1682
Impact energy in the end positions for P cushioning ¹⁾	0.03	0.05	0.07	0.15	0.20	0.30	0.40	0.70	1.00	1.30

1) The values are reduced by approx. 50% at an ambient temperature of 80°C

Average piston speed v as a function of payload m in combination with cushioning PPS

Piston \varnothing 16

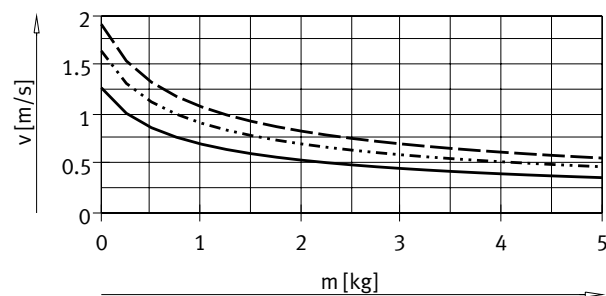

— DSNU-16-50
 DSNU-16-100
 - - - DSNU-16-200

Piston \varnothing 20

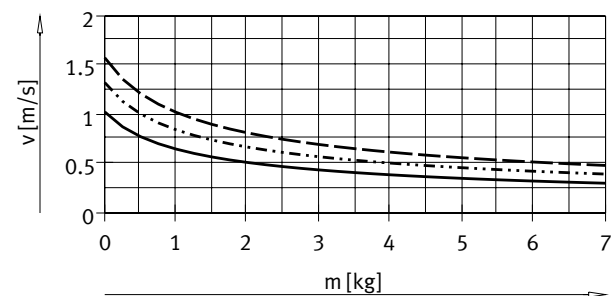

— DSNU-20-50
 DSNU-20-100
 - - - DSNU-20-200

Piston \varnothing 25

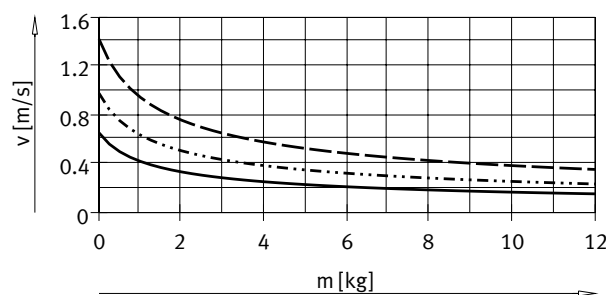

— DSNU-25-50
 DSNU-25-100
 - - - DSNU-25-200

Piston \varnothing 32

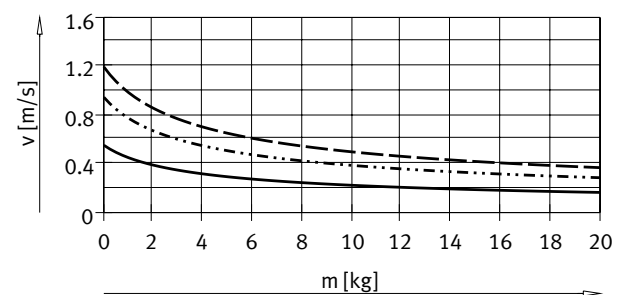

— DSNU-32-50
 DSNU-32-100
 - - - DSNU-32-200

Datasheet

Average piston speed v as a function of payload m in combination with cushioning PPS

Piston \varnothing 40

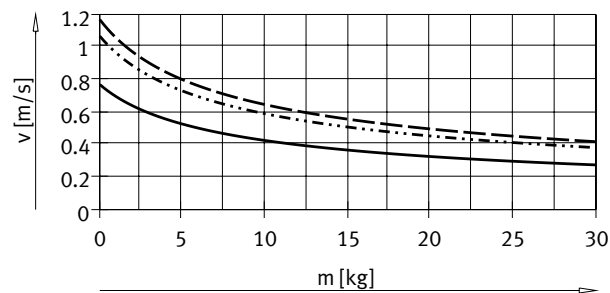

- DSNU-40-50
- ⋯ DSNU-40-100
- - - DSNU-40-200

Piston \varnothing 50

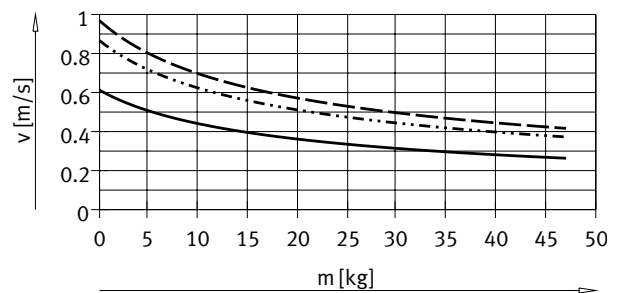

- DSNU-50-50
- ⋯ DSNU-50-100
- - - DSNU-50-200

Piston \varnothing 63

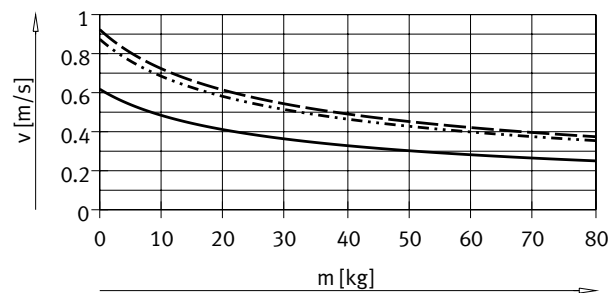

- DSNU-63-50
- ⋯ DSNU-63-100
- - - DSNU-63-200

Note:

Engineering software for
 P cushioning
 PPV cushioning
 PPS cushioning
 → <https://www.festo.com/x/pneumatic-sizing>

Average piston speed = Stroke/
 movement time

Datasheet

Max. transverse force F_q as a function of projection l

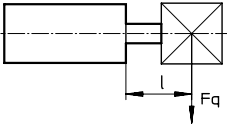

DSNU-...

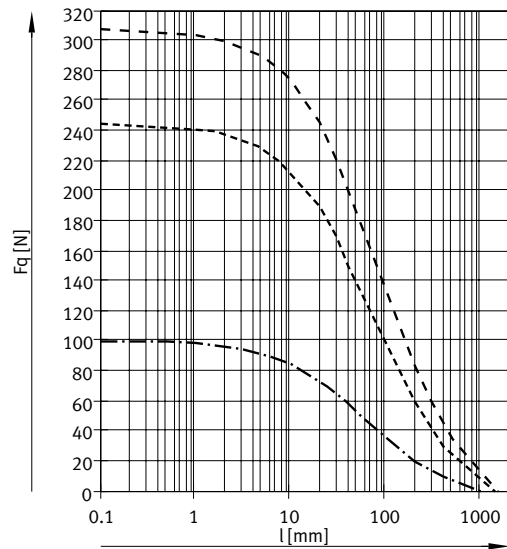
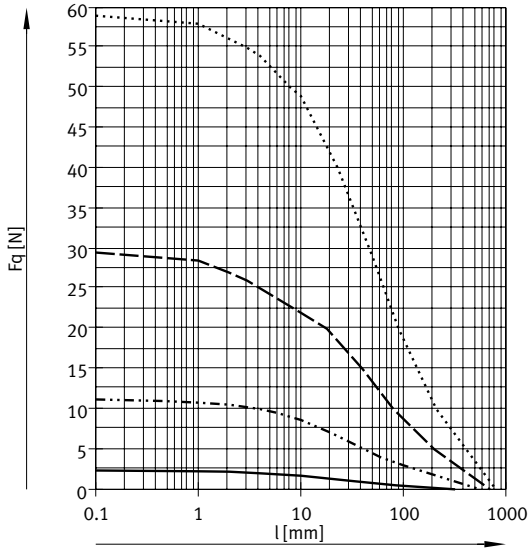

- DSNU-8/10
- · - · - DSNU-12/16
- - - DSNU-20
- · · · · DSNU-25

- · - · - DSNU-32
- - - DSNU-40
- - - DSNU-50/63

DSNU-...S2 – Through piston rod

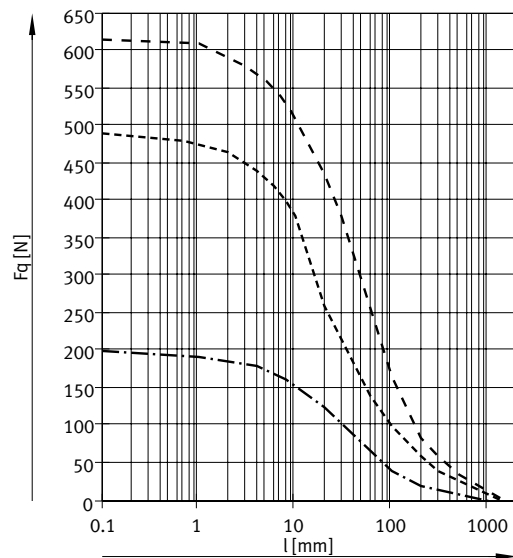
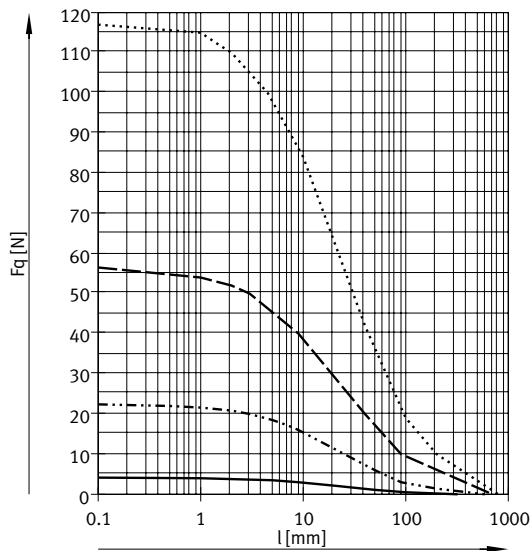

- DSNU-8/10
- · - · - DSNU-12/16
- - - DSNU-20
- · · · · DSNU-25

- · - · - DSNU-32
- - - DSNU-40
- - - DSNU-50/63

Datasheet

Materials

Sectional view

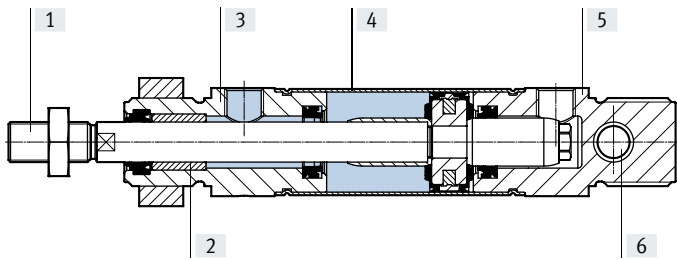

Round cylinder	8 ... 25	32 ... 63
[1] Piston rod		
DSNU-...	High-alloy steel	
DSNU-...-R3	High-alloy stainless steel	
DSNU-...-A6	–	Hard-chrome-plated tempered steel
[2] Piston rod bearing	Sintered bronze	
[3] Bearing cap	Colourless anodised wrought aluminium alloy	
[4] Cylinder barrel	High-alloy stainless steel	
[5] End cap	Colourless anodised wrought aluminium alloy	
[6] Swivel bearing	Polymer	
– Seals		
DSNU-...	TPE-U(PU), NBR	
DSNU-...-S6	FPM	
DSNU-...-S10/-L	FPM	FPM, TPE-U(PU)
DSNU-...-R3	TPE-U (PUR) media seal (modified for resistance to hydrolysis and cleaning)	
Piston rod scraper		
DSNU-...-A6	–	CuZn
PWIS conformity	VDMA24364-B1/B2-L ¹⁾	
Cleanroom class	Class 6 according to ISO 14644-1	
Note on materials		
DSNU-...	RoHS-compliant	
DSNU-...-S10	Contains paint-wetting impairment substances	
DSNU-...-F1A	Metals with more than 1% copper, zinc or nickel by mass are excluded from use. Exceptions are nickel in steel, chemically nickel-plated surfaces, printed circuit boards, cables, electrical plug connectors and coils	

1) Applies to all variants except S10

Datasheet

Dimensions

Download CAD data → www.festo.com

DSNU-8 ... 25

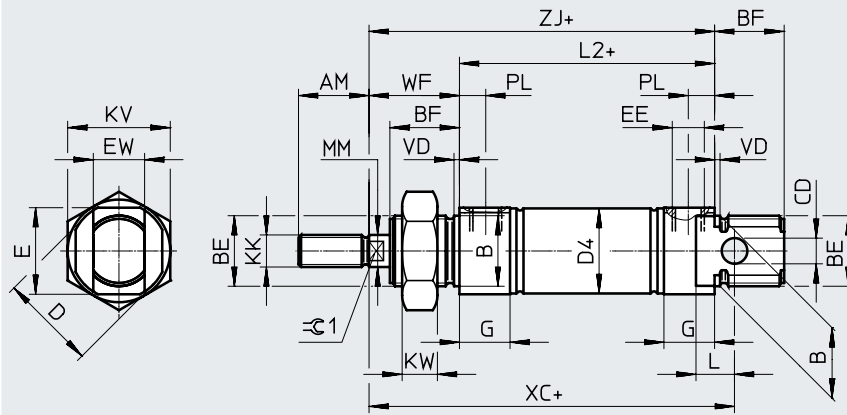

 **Note**
 Piston rod nut is not included in the scope of delivery for diameter 8 ... 20.
 + = plus stroke length

∅ [mm]	AM	B ∅ h8	BE	BF	CD ∅ H9	D ∅	D4 ∅	E	EE	EW	G
8	12	12	M12x1.25	12	4	16	9.3	14	M5	8	10
10							11.3				
12	16	16	M16x1.5	17	6	20	13.3	18	G1/8	12	16
16							17.3				
20	20	22	M22x1.5	20	8	30	21.3	26	16	16	
25	22			22			22				26.5

∅ [mm]	KK	KV	KW	MM ∅	L	L2	PL	VD	WF ±1.2	XC ±1	ZJ	∅1
8	M4	19	6	4	6	46	6	2	16	64	62	-
10												
12	M6	24	8	6	9	50	6	2	22	75	72	5
16						56						
20	M8	32	11	8	12	68	8.2	2	24	95	92	7
25	M10x1.25			10		69.5			28	104	97.5	9

Datasheet

Dimensions

Download CAD data → www.festo.com

DSNU-8 ... 25

MQ – Lateral supply port, short end cap

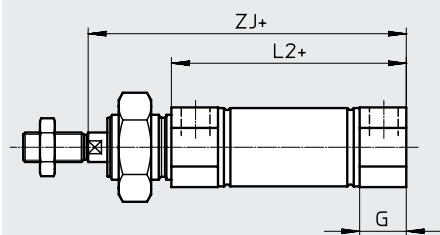

MA – Axial supply port, short end cap

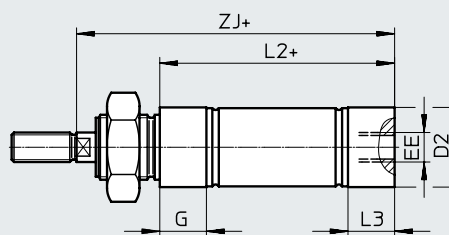

MH – With direct mounting

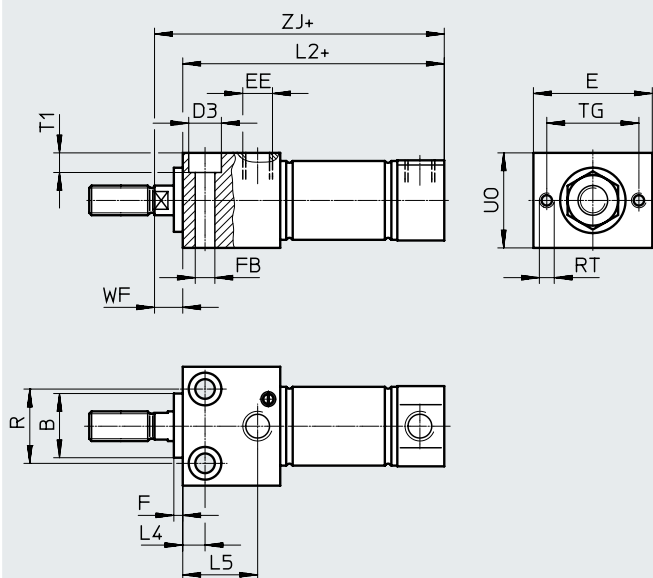

+ = plus stroke length

∅ [mm]	B ∅ h8	D2 ∅	D3 ∅	E	EE	F	FB ∅	G	L2		
									DSNU-...		
									-MQ	-MA	-MH
8	12	10.5	6	24	M5	3	3.4	10	46	43.6	53.5
10		12.5		43.1					53.8		
12	16	14.5	8	30	G1/8	4.5	5.5	16	50	47.7	62
16		17.5		56					53.7	67.8	
20	22	21.7	10	40	6.6	6.6	6.6	16	68	66.5	81.5
25		26.7		11					69.5	68.5	86.2

∅ [mm]	L3	L4	L5	R	RT	TG	T1	U0	WF	ZJ		
										DSNU-...		
										-MQ	-MA	-MH
8	7.6	5	14	12	M3	18	3.4	16	8	62	59.6	61.5
10	7.1									59.1	61.8	
12	7.7	6	18.1	16	M4	23	4.5	22	10	72	69.7	72
16										78	75.7	77.8
20	14.5	7.5	22.4	22	M5	31	5.5	28	11	92	90.5	91.5
25	14		25.2	25			6.6	32		97.5	96.5	97.2

Datasheet

Download CAD data → www.festo.com

Dimensions

DSNU-8 ... 25

S2 – Through piston rod

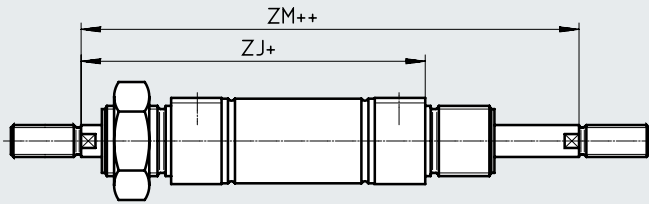

Note

The thread types at both piston rod ends are identical. In combination with variant Q, the left piston rod end is square, the right piston rod end round.

+ = plus stroke length

++ = plus 2x stroke length

K2 – Extended male piston rod thread

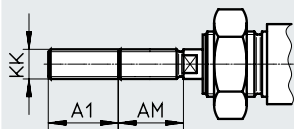

K6 – Shortened male piston rod thread

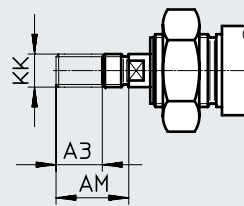

K3 – Female piston rod thread

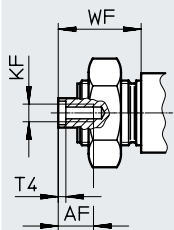

K5 – Custom piston rod thread

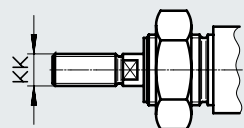

K8 – Extended piston rod

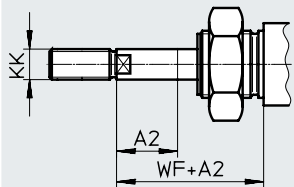

Note

If variant K8 is required in combination with S2, the piston rod will only be extended at one end.

∅ [mm]	A1 max.	A2 max.	A3 max.	AF	AM	KF	KK		T4	WF ±1.2	ZJ			ZM
							Basic thread	Custom thread ¹⁾			DSNU-...			
											-MQ	-MA	-MH	
8	15	50	4	-	12	-	M4	-	16	62	59.6	61.5	78.4	
10				-		-		59.1			61.8			
12				-		-		69.7			72			
16	20	100	8	-	16	-	M6	-	22	72	75.7	77.8	94	
20				25		110		12			20	M4	M8	-
25	35	150	8	12	22	M6	M10x1.25	M10	2.6	28	97.5	96.5	97.2	125.5

1) The custom threads are only available as male threads. The scope of delivery does not include a hex nut for the piston rod thread

Datasheet

Dimensions

Download CAD data → www.festo.com

DSNU-32 ... 63

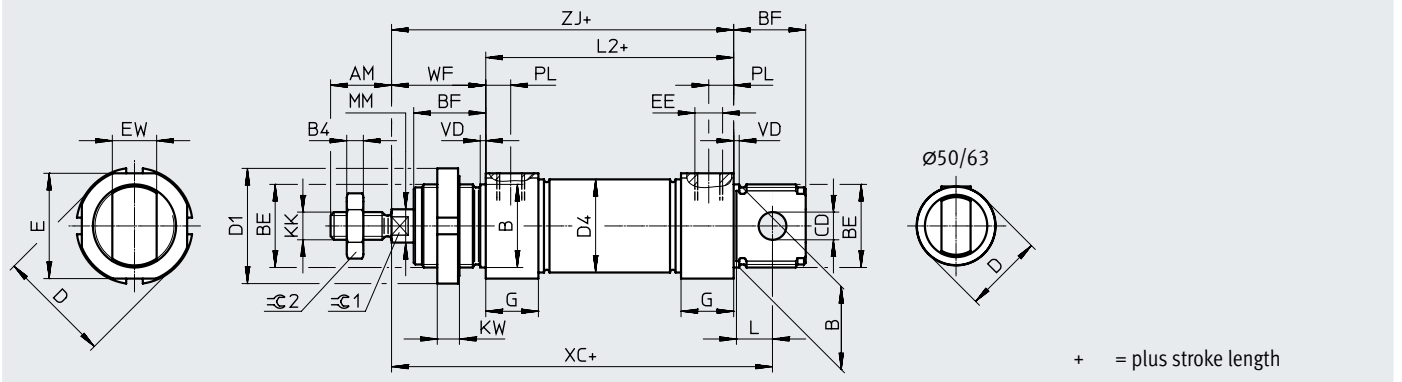

∅	AM	B ∅ h8	BE	BF	B4	CD ∅ H9	D ∅	D1 ∅	D4 ∅	E	EE	EW
32	22	30	M30x1.5	26	5	10	41	42	33.6	38	G1/8	16
40	24	38	M38x1.5	30	6	12	49	50	41.6	45	G1/4	18
50	32	45	M45x1.5	33	8	16	57	60	52.4	-	G3/8	21
63							70		65.4			

∅	G	KK	KW	MM ∅	L	L2	PL	VD	WF ±1.2	XC ±1	ZJ	⊖1	⊖2
32	19	M10x1.25	8	12	13	69.5	9	2	34	117.5	103.5	10	16
40	25	M12x1.25	10	16	15	84.6	12	3	39	139.6	123.6	13	18
50		M16x1.5		20	16	86.2			44	147.2	130.2	17	24
63	28					94.2	13		45	156.2	139.2		

Datasheet

Dimensions

Download CAD data → www.festo.com

DSNU-32 ... 63

MQ – Lateral supply port, short end cap

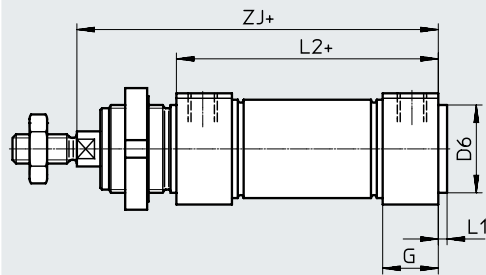

MA – Axial supply port, short end cap

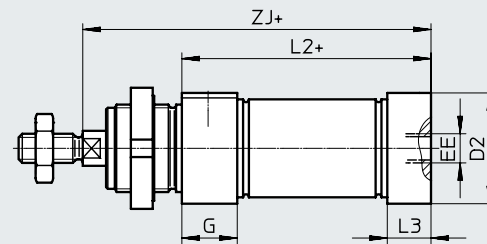

MH – With direct mounting

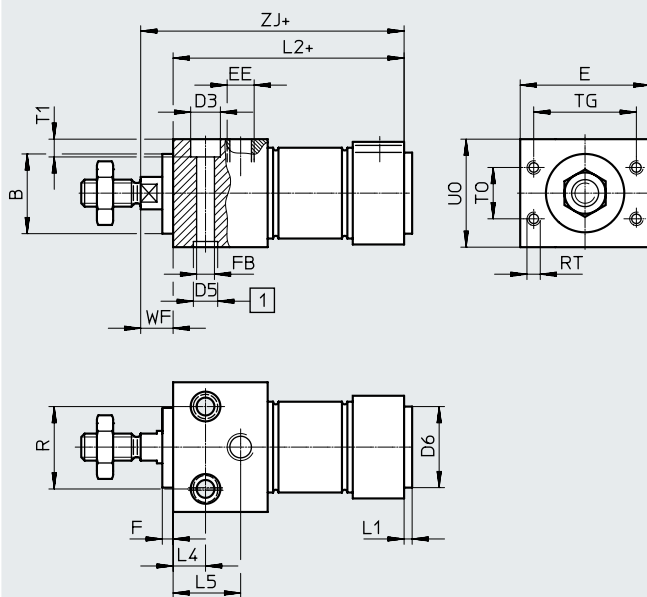

[1] Centring holes
(2 centring sleeves included in the scope of delivery)
+ = plus stroke length

∅ [mm]	B ∅ h8	B2	E	EE	G	F	FB ∅	D2 ∅	D3 ∅	D5 ∅	D6 ∅	L1	L2			
													DSNU-...			
													-MQ	-MA	-MH	
32	30	1	48	G1/8	19	4	6.6	34	11	9	30	3	69.5	65.5	85.5	
40	38		54	G1/4	25		9	42	14	12	38	4	84.6	77.6	104.6	
50	45	64	63		2	72	G3/8	28		11	66		18	15	45	86.2
63															94.2	94.2

∅ [mm]	L3	L4	L5	R	RT	T0	T1	T2	TG	U0	WF	ZJ		
												DSNU-...		
												-MQ	-MA	-MH
32	15	12	25	30	M5	19	6.6	2.1	38	40	12	103.5	99.5	97.5
40	18	15	32	38		24	9	2.6	42	48		123.6	116.6	116.6
50	25		35	42	M6	32			50	58	15	130.2	130.2	124.2
63	28	36	44	M8	36	11	3.1	52	72	139.2		139.2	132.2	

Datasheet

Dimensions

Download CAD data → www.festo.com

DSNU-32 ... 63
S2 – Through piston rod

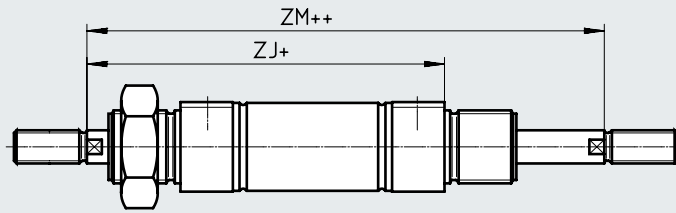

Note

The thread types at both piston rod ends are identical. In combination with variant Q, the left piston rod end is square, the right piston rod end round.

+ = plus stroke length
++ = plus 2x stroke length

K2 – Extended male piston rod thread

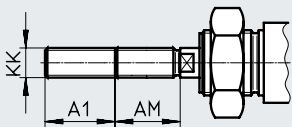

K6 – Shortened male piston rod thread

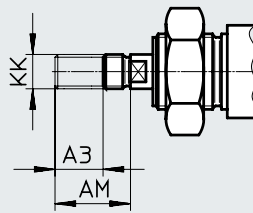

K3 – Female piston rod thread

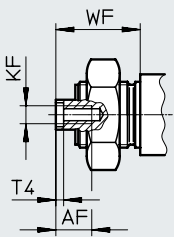

K5 – Custom piston rod thread

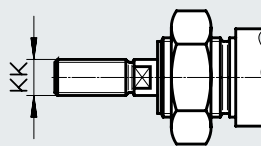

K8 – Extended piston rod

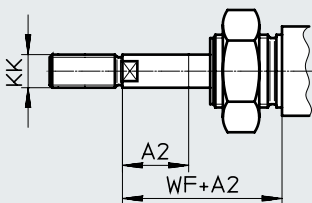

Note

If variant K8 is required in combination with S2, the piston rod will only be extended at one end.

∅ [mm]	A1 max.	A2 max.	A3 max.	AF	AM	KF	KK		T4	WF ±1.2	ZJ			ZM
							Basic thread	Custom thread ¹⁾			DSNU-...			
											-MQ	-MA	-MH	
32	35	500	8	12	22	M6	M10x1.25	M10	2.6	34	103.5	99.5	97.5	137.5
40					24	M8	M12x1.25	M12	3.3	39	123.6	111.6	116.6	162.6
50	70		10	16	32	M10	M16x1.5	M16	4.7	44	130.2	130.2	124.2	174.2
63		45	139.2	139.2	132.2	184.2								

1) The custom threads are only available as male threads. The scope of delivery does not include a hex nut for the piston rod thread

Datasheet

★ Core Range

Ordering data				PPV – Pneumatic cushioning, adjustable at both ends		PPS – Pneumatic cushioning, self-adjusting at both ends	
Piston ø	Stroke	P – Elastic cushioning rings/pads at both ends	A – With position sensing	A – With position sensing		A – With position sensing	
[mm]	[mm]	Part no.	Type	Part no.	Type	Part no.	Type
12	10	★ 19189	DSNU-12-10-P-A	-		-	
	15	★ 1908255	DSNU-12-15-P-A	-		-	
	20	★ 1908256	DSNU-12-20-P-A	-		-	
	25	★ 19190	DSNU-12-25-P-A	-		-	
	30	★ 1908257	DSNU-12-30-P-A	-		-	
	40	★ 19191	DSNU-12-40-P-A	-		-	
	50	★ 19192	DSNU-12-50-P-A	-		-	
	60	★ 1908258	DSNU-12-60-P-A	-		-	
	80	★ 19193	DSNU-12-80-P-A	-		-	
	100	★ 19194	DSNU-12-100-P-A	-		-	
	125	★ 19195	DSNU-12-125-P-A	-		-	
	160	★ 19196	DSNU-12-160-P-A	-		-	
	200	★ 19197	DSNU-12-200-P-A	-		-	
16	10	★ 19198	DSNU-16-10-P-A	★ 1908266	DSNU-16-10-PPV-A	★ 1908274	DSNU-16-10-PPS-A
	15	★ 1908259	DSNU-16-15-P-A	★ 1908267	DSNU-16-15-PPV-A	★ 1908275	DSNU-16-15-PPS-A
	20	★ 1908260	DSNU-16-20-P-A	★ 1908268	DSNU-16-20-PPV-A	★ 1908276	DSNU-16-20-PPS-A
	25	★ 19199	DSNU-16-25-P-A	★ 33973	DSNU-16-25-PPV-A	★ 559263	DSNU-16-25-PPS-A
	30	★ 1908261	DSNU-16-30-P-A	★ 1908269	DSNU-16-30-PPV-A	★ 1908277	DSNU-16-30-PPS-A
	35	★ 1908262	DSNU-16-35-P-A	★ 1908270	DSNU-16-35-PPV-A	★ 1908278	DSNU-16-35-PPS-A
	40	★ 19200	DSNU-16-40-P-A	★ 19229	DSNU-16-40-PPV-A	★ 559264	DSNU-16-40-PPS-A
	50	★ 19201	DSNU-16-50-P-A	★ 19230	DSNU-16-50-PPV-A	★ 559265	DSNU-16-50-PPS-A
	60	★ 1908263	DSNU-16-60-P-A	★ 1908271	DSNU-16-60-PPV-A	★ 1908279	DSNU-16-60-PPS-A
	70	★ 1908264	DSNU-16-70-P-A	★ 1908272	DSNU-16-70-PPV-A	★ 1908280	DSNU-16-70-PPS-A
	80	★ 19202	DSNU-16-80-P-A	★ 19231	DSNU-16-80-PPV-A	★ 559266	DSNU-16-80-PPS-A
	100	★ 19203	DSNU-16-100-P-A	★ 19232	DSNU-16-100-PPV-A	★ 559267	DSNU-16-100-PPS-A
	125	★ 19204	DSNU-16-125-P-A	★ 19233	DSNU-16-125-PPV-A	★ 559268	DSNU-16-125-PPS-A
	150	★ 1908265	DSNU-16-150-P-A	★ 1908273	DSNU-16-150-PPV-A	★ 1908281	DSNU-16-150-PPS-A
	160	★ 19205	DSNU-16-160-P-A	★ 19234	DSNU-16-160-PPV-A	★ 559269	DSNU-16-160-PPS-A
	200	★ 19206	DSNU-16-200-P-A	★ 19235	DSNU-16-200-PPV-A	★ 559270	DSNU-16-200-PPS-A

Datasheet

★ Core Range

Ordering data				PPV – Pneumatic cushioning, adjustable at both ends		PPS – Pneumatic cushioning, self-adjusting at both ends	
Piston ø	Stroke	P – Elastic cushioning rings/pads at both ends	A – With position sensing	A – With position sensing	A – With position sensing	A – With position sensing	A – With position sensing
[mm]	[mm]	Part no.	Type	Part no.	Type	Part no.	Type
20	10	★ 19207	DSNU-20-10-P-A	★ 1908289	DSNU-20-10-PPV-A	★ 1908297	DSNU-20-10-PPS-A
	15	★ 1908282	DSNU-20-15-P-A	★ 1908290	DSNU-20-15-PPV-A	★ 1908298	DSNU-20-15-PPS-A
	20	★ 1908283	DSNU-20-20-P-A	★ 1908291	DSNU-20-20-PPV-A	★ 1908299	DSNU-20-20-PPS-A
	25	★ 19208	DSNU-20-25-P-A	★ 33974	DSNU-20-25-PPV-A	★ 559271	DSNU-20-25-PPS-A
	30	★ 1908284	DSNU-20-30-P-A	★ 1908292	DSNU-20-30-PPV-A	★ 1908300	DSNU-20-30-PPS-A
	35	★ 1908285	DSNU-20-35-P-A	★ 1908293	DSNU-20-35-PPV-A	★ 1908301	DSNU-20-35-PPS-A
	40	★ 19209	DSNU-20-40-P-A	★ 19236	DSNU-20-40-PPV-A	★ 559272	DSNU-20-40-PPS-A
	50	★ 19210	DSNU-20-50-P-A	★ 19237	DSNU-20-50-PPV-A	★ 559273	DSNU-20-50-PPS-A
	60	★ 1908286	DSNU-20-60-P-A	★ 1908294	DSNU-20-60-PPV-A	★ 1908302	DSNU-20-60-PPS-A
	70	★ 1908287	DSNU-20-70-P-A	★ 1908295	DSNU-20-70-PPV-A	★ 1908303	DSNU-20-70-PPS-A
	80	★ 19211	DSNU-20-80-P-A	★ 19238	DSNU-20-80-PPV-A	★ 559274	DSNU-20-80-PPS-A
	100	★ 19212	DSNU-20-100-P-A	★ 19239	DSNU-20-100-PPV-A	★ 559275	DSNU-20-100-PPS-A
	125	★ 19213	DSNU-20-125-P-A	★ 19240	DSNU-20-125-PPV-A	★ 559276	DSNU-20-125-PPS-A
	150	★ 1908288	DSNU-20-150-P-A	★ 1908296	DSNU-20-150-PPV-A	★ 1908304	DSNU-20-150-PPS-A
	160	★ 19214	DSNU-20-160-P-A	★ 19241	DSNU-20-160-PPV-A	★ 559277	DSNU-20-160-PPS-A
	200	★ 19215	DSNU-20-200-P-A	★ 19242	DSNU-20-200-PPV-A	★ 559278	DSNU-20-200-PPS-A
	250	★ 19216	DSNU-20-250-P-A	★ 19243	DSNU-20-250-PPV-A	★ 559279	DSNU-20-250-PPS-A
	300	★ 19217	DSNU-20-300-P-A	★ 19244	DSNU-20-300-PPV-A	★ 559280	DSNU-20-300-PPS-A
320	★ 34718	DSNU-20-320-P-A	★ 34720	DSNU-20-320-PPV-A	★ 559281	DSNU-20-320-PPS-A	
25	10	★ 19218	DSNU-25-10-P-A	★ 1908312	DSNU-25-10-PPV-A	★ 1908320	DSNU-25-10-PPS-A
	15	★ 1908305	DSNU-25-15-P-A	★ 1908313	DSNU-25-15-PPV-A	★ 1908321	DSNU-25-15-PPS-A
	20	★ 1908306	DSNU-25-20-P-A	★ 1908314	DSNU-25-20-PPV-A	★ 1908322	DSNU-25-20-PPS-A
	25	★ 19219	DSNU-25-25-P-A	★ 33975	DSNU-25-25-PPV-A	★ 559282	DSNU-25-25-PPS-A
	30	★ 1908307	DSNU-25-30-P-A	★ 1908315	DSNU-25-30-PPV-A	★ 1908323	DSNU-25-30-PPS-A
	35	★ 1908308	DSNU-25-35-P-A	★ 1908316	DSNU-25-35-PPV-A	★ 1908324	DSNU-25-35-PPS-A
	40	★ 19220	DSNU-25-40-P-A	★ 19245	DSNU-25-40-PPV-A	★ 559283	DSNU-25-40-PPS-A
	50	★ 19221	DSNU-25-50-P-A	★ 19246	DSNU-25-50-PPV-A	★ 559284	DSNU-25-50-PPS-A
	60	★ 1908309	DSNU-25-60-P-A	★ 1908317	DSNU-25-60-PPV-A	★ 1908325	DSNU-25-60-PPS-A
	70	★ 1908310	DSNU-25-70-P-A	★ 1908318	DSNU-25-70-PPV-A	★ 1908326	DSNU-25-70-PPS-A
	80	★ 19222	DSNU-25-80-P-A	★ 19247	DSNU-25-80-PPV-A	★ 559285	DSNU-25-80-PPS-A
	100	★ 19223	DSNU-25-100-P-A	★ 19248	DSNU-25-100-PPV-A	★ 559286	DSNU-25-100-PPS-A
	125	★ 19224	DSNU-25-125-P-A	★ 19249	DSNU-25-125-PPV-A	★ 559287	DSNU-25-125-PPS-A
	150	★ 1908311	DSNU-25-150-P-A	★ 1908319	DSNU-25-150-PPV-A	★ 1908327	DSNU-25-150-PPS-A
	160	★ 19225	DSNU-25-160-P-A	★ 19250	DSNU-25-160-PPV-A	★ 559288	DSNU-25-160-PPS-A
	200	★ 19226	DSNU-25-200-P-A	★ 19251	DSNU-25-200-PPV-A	★ 559289	DSNU-25-200-PPS-A
	250	★ 19227	DSNU-25-250-P-A	★ 19252	DSNU-25-250-PPV-A	★ 559290	DSNU-25-250-PPS-A
	300	★ 19228	DSNU-25-300-P-A	★ 19253	DSNU-25-300-PPV-A	★ 559291	DSNU-25-300-PPS-A
320	★ 34719	DSNU-25-320-P-A	★ 34721	DSNU-25-320-PPV-A	★ 559292	DSNU-25-320-PPS-A	

Datasheet

Ordering data				PPV – Pneumatic cushioning, adjustable at both ends		PPS – Pneumatic cushioning, self-adjusting at both ends					
Piston \varnothing	Stroke	P – Elastic cushioning rings/pads at both ends		A – With position sensing		A – With position sensing					
[mm]	[mm]	Part no.	Type	Part no.	Type	Part no.	Type				
8	10	19177	DSNU-8-10-P-A	-		-					
	15	1908247	DSNU-8-15-P-A								
	20	1908248	DSNU-8-20-P-A								
	25	19178	DSNU-8-25-P-A								
	30	1908249	DSNU-8-30-P-A								
	40	19179	DSNU-8-40-P-A								
	50	19180	DSNU-8-50-P-A								
	60	1908250	DSNU-8-60-P-A								
	80	19181	DSNU-8-80-P-A								
	100	19182	DSNU-8-100-P-A								
10	10	19183	DSNU-10-10-P-A	-		-					
	15	1908251	DSNU-10-15-P-A								
	20	1908252	DSNU-10-20-P-A								
	25	19184	DSNU-10-25-P-A								
	30	1908253	DSNU-10-30-P-A								
	40	19185	DSNU-10-40-P-A								
	50	19186	DSNU-10-50-P-A								
	60	1908254	DSNU-10-60-P-A								
	80	19187	DSNU-10-80-P-A								
	100	19188	DSNU-10-100-P-A								
12	70	5249943	DSNU-12-70-P-A	-		-					
	150	5249947	DSNU-12-150-P-A								
25	400	35191	DSNU-25-400-P-A	35193	DSNU-25-400-PPV-A	559293	DSNU-25-400-PPS-A				
	500	35192	DSNU-25-500-P-A	35194	DSNU-25-500-PPV-A	559294	DSNU-25-500-PPS-A				
32	10	5249365	DSNU-32-10-P-A	-		-					
	15	5249366	DSNU-32-15-P-A								
	20	5249367	DSNU-32-20-P-A								
	25	195980	DSNU-32-25-P-A					196020	DSNU-32-25-PPV-A	559295	DSNU-32-25-PPS-A
	30	5249368	DSNU-32-30-P-A					5249851	DSNU-32-30-PPV-A	5249968	DSNU-32-30-PPS-A
	40	195981	DSNU-32-40-P-A					196021	DSNU-32-40-PPV-A	559296	DSNU-32-40-PPS-A
	50	195982	DSNU-32-50-P-A					196022	DSNU-32-50-PPV-A	559297	DSNU-32-50-PPS-A
	60	5249369	DSNU-32-60-P-A					5249853	DSNU-32-60-PPV-A	5249970	DSNU-32-60-PPS-A
	70	5249370	DSNU-32-70-P-A					5249854	DSNU-32-70-PPV-A	5249971	DSNU-32-70-PPS-A
	80	195983	DSNU-32-80-P-A					196023	DSNU-32-80-PPV-A	559298	DSNU-32-80-PPS-A
	100	195984	DSNU-32-100-P-A					196024	DSNU-32-100-PPV-A	559299	DSNU-32-100-PPS-A
	125	195985	DSNU-32-125-P-A					196025	DSNU-32-125-PPV-A	559300	DSNU-32-125-PPS-A
	150	5249371	DSNU-32-150-P-A					5249855	DSNU-32-150-PPV-A	5249972	DSNU-32-150-PPS-A
	160	195986	DSNU-32-160-P-A					196026	DSNU-32-160-PPV-A	559301	DSNU-32-160-PPS-A
	200	195987	DSNU-32-200-P-A					196027	DSNU-32-200-PPV-A	559302	DSNU-32-200-PPS-A
	250	195988	DSNU-32-250-P-A					196028	DSNU-32-250-PPV-A	559303	DSNU-32-250-PPS-A
	300	5249372	DSNU-32-300-P-A					5249856	DSNU-32-300-PPV-A	5249973	DSNU-32-300-PPS-A
	320	195989	DSNU-32-320-P-A					196029	DSNU-32-320-PPV-A	559304	DSNU-32-320-PPS-A

Datasheet

Ordering data				PPV – Pneumatic cushioning, adjustable at both ends		PPS – Pneumatic cushioning, self-adjusting at both ends	
Piston ø	Stroke	P – Elastic cushioning rings/pads at both ends	A – With position sensing	A – With position sensing		A – With position sensing	
[mm]	[mm]	Part no.	Type	Part no.	Type	Part no.	Type
40	10	5262529	DSNU-40-10-P-A	-		-	
	15	5262530	DSNU-40-15-P-A	-		-	
	20	5262531	DSNU-40-20-P-A	-		-	
	25	195990	DSNU-40-25-P-A	196030	DSNU-40-25-PPV-A	559305	DSNU-40-25-PPS-A
	30	5262532	DSNU-40-30-P-A	5262705	DSNU-40-30-PPV-A	5262768	DSNU-40-30-PPS-A
	40	195991	DSNU-40-40-P-A	196031	DSNU-40-40-PPV-A	559306	DSNU-40-40-PPS-A
	50	195992	DSNU-40-50-P-A	196032	DSNU-40-50-PPV-A	559307	DSNU-40-50-PPS-A
	60	5262534	DSNU-40-60-P-A	5262706	DSNU-40-60-PPV-A	5262769	DSNU-40-60-PPS-A
	70	5262535	DSNU-40-70-P-A	5262707	DSNU-40-70-PPV-A	5262771	DSNU-40-70-PPS-A
	80	195993	DSNU-40-80-P-A	196033	DSNU-40-80-PPV-A	559308	DSNU-40-80-PPS-A
	100	195994	DSNU-40-100-P-A	196034	DSNU-40-100-PPV-A	559309	DSNU-40-100-PPS-A
	125	195995	DSNU-40-125-P-A	196035	DSNU-40-125-PPV-A	559310	DSNU-40-125-PPS-A
	150	5262536	DSNU-40-150-P-A	5262708	DSNU-40-150-PPV-A	5262772	DSNU-40-150-PPS-A
	160	195996	DSNU-40-160-P-A	196036	DSNU-40-160-PPV-A	559311	DSNU-40-160-PPS-A
	200	195997	DSNU-40-200-P-A	196037	DSNU-40-200-PPV-A	559312	DSNU-40-200-PPS-A
	50	25	196000	DSNU-50-25-P-A	196040	DSNU-50-25-PPV-A	559315
40		196001	DSNU-50-40-P-A	196041	DSNU-50-40-PPV-A	559316	DSNU-50-40-PPS-A
50		196002	DSNU-50-50-P-A	196042	DSNU-50-50-PPV-A	559317	DSNU-50-50-PPS-A
80		196003	DSNU-50-80-P-A	196043	DSNU-50-80-PPV-A	559318	DSNU-50-80-PPS-A
100		196004	DSNU-50-100-P-A	196044	DSNU-50-100-PPV-A	559319	DSNU-50-100-PPS-A
125		196005	DSNU-50-125-P-A	196045	DSNU-50-125-PPV-A	559320	DSNU-50-125-PPS-A
160		196006	DSNU-50-160-P-A	196046	DSNU-50-160-PPV-A	559321	DSNU-50-160-PPS-A
200		196007	DSNU-50-200-P-A	196047	DSNU-50-200-PPV-A	559322	DSNU-50-200-PPS-A
63	25	196010	DSNU-63-25-P-A	196050	DSNU-63-25-PPV-A	559325	DSNU-63-25-PPS-A
	40	196011	DSNU-63-40-P-A	196051	DSNU-63-40-PPV-A	559326	DSNU-63-40-PPS-A
	50	196012	DSNU-63-50-P-A	196052	DSNU-63-50-PPV-A	559327	DSNU-63-50-PPS-A
	80	196013	DSNU-63-80-P-A	196053	DSNU-63-80-PPV-A	559328	DSNU-63-80-PPS-A
	100	196014	DSNU-63-100-P-A	196054	DSNU-63-100-PPV-A	559329	DSNU-63-100-PPS-A
	125	196015	DSNU-63-125-P-A	196055	DSNU-63-125-PPV-A	559330	DSNU-63-125-PPS-A
	160	196016	DSNU-63-160-P-A	196056	DSNU-63-160-PPV-A	559331	DSNU-63-160-PPS-A
	200	196017	DSNU-63-200-P-A	196057	DSNU-63-200-PPV-A	559332	DSNU-63-200-PPS-A
250	196018	DSNU-63-250-P-A	196058	DSNU-63-250-PPV-A	559333	DSNU-63-250-PPS-A	
320	196019	DSNU-63-320-P-A	196059	DSNU-63-320-PPV-A	559334	DSNU-63-320-PPS-A	

Datasheet

Ordering data					
Piston \varnothing	Stroke	P – Elastic cushioning rings/pads at both ends		PPV – Pneumatic cushioning, adjustable at both ends	
[mm]	[mm]	A – With position sensing		A – With position sensing	
		Part no.	Type	Part no.	Type
Variable stroke					
8	1 ... 100	14326	DSNU-8-...-P-A		
10	1 ... 100	14325	DSNU-10-...-P-A		
12	1 ... 200	14324	DSNU-12-...-P-A		
16	1 ... 200	14323	DSNU-16-...-P-A		
20	1 ... 320	14328	DSNU-20-...-P-A		
25	1 ... 500	14327	DSNU-25-...-P-A		
Variable stroke					
–					
		14320	DSNU-16-...-PPV-A		
		14321	DSNU-20-...-PPV-A		
		14322	DSNU-25-...-PPV-A		

Ordering data – Modular product system

Ordering table									
Size	8	10	12	16	20	25	Conditions	Code	Enter code
Module no.	193986	193987	193988	193989	193990	193991			
Function	Round cylinder, double-acting, based on ISO 6432							DSNU	DSNU
Piston ø [mm]	8	10	12	16	20	25		★ -...	
Stroke [mm]	1 ... 100		1 ... 200		1 ... 320	1 ... 500	[1]	★ -...	
Cushioning	Elastic cushioning rings/pads at both ends							★ -P	
	-		-		Pneumatic cushioning, adjustable at both ends		[2]	★ -PPV	
	-		-		Pneumatic cushioning, self-adjusting at both ends		[3]	★ -PPS	
Position sensing	Via proximity switch						[4]	★ -A	-A
Cylinder cap	Lateral supply port, short end cap						[5]	★ -MQ	
	Axial supply port, short end cap						[5]	-MA	
	With mounting flange at front (direct mounting), bearing cap						[6]	-MH	
Piston rod	Through piston rod						[7]	★ -S2	

- [1] -... Longer strokes on request
- [2] PPV Not with MA. In combination with S6, S10, L, A1 not with piston diameter 12 mm
- [3] PPS Not with MA, MH, S6, S10 and not with combination MQ-R3
- [4] A Minimum stroke ≥ 10 mm required for reliable sensing
- [5] MQ, MA Not with S2, S10
- [6] MH Not with combination S6-R3. Not with S10
- [7] S2 Not with S10



Note

The bellows kit DADB must not be used in combination with the variant MH.
The running characteristics change slightly when the bellows kit DADB is combined with the variant S10 or L



Note

Cylinders with position sensing require a minimum stroke of 10 mm to ensure reliable sensing.
Longer strokes on request

Ordering data – Modular product system

Ordering table		8	10	12	16	20	25	Conditions	Code	Enter code	
Extended male thread		Extended male piston rod thread									
	[mm]	1 ... 15		1 ... 20		1 ... 25	1 ... 35	[8]	-...K2		
Shortened male thread		Shortened male piston rod thread									
	[mm]	1 ... 4				1 ... 8	1 ... 10	[9]	-...K6		
Female thread		Piston rod with female thread									
		-	-	-	-	(M4)	(M6)	[10]	★ -K3		
Custom thread		Custom thread on the piston rod									
		-	-	-	-	-	M10		-“...”K5		
Extended piston rod at one end		Piston rod extended at one end									
	[mm]	1 ... 50		1 ... 100		1 ... 110	1 ... 150		★ ...K8		
Temperature resistance		Heat-resistant seals max. 120°C						[11]	★ -S6		
Constant motion		-	-	Slow speed (constant motion at low piston speeds)			[12]	-S10			
Running characteristic		Low friction					[13]	-L			
Corrosion protection		-	-	High corrosion protection				★ -R3			
Scraper		-	-	Increased chemical resistance			[14]	-A1			
EU certification		II 2GD					[15]	-EX4			

[8]	K2	Not with K3, K6
[9]	K6	Not with K3
[10]	K3	Not with K5
[11]	S6	Not with S10
[12]	S10	Not with R3, L
[13]	L	Not with MQ, MA, MH, S2, S6, S10
[14]	A1	Not with MH, S6, S10, L
[15]	EX4	Not with S6

Ordering data – Modular product system

Ordering table							
Size	32	40	50	63	Conditions	Code	Enter code
Module no.	193992	193993	193994	193995			
Function	Double-acting round cylinder					DSNU	DSNU
Piston ø [mm]	32	40	50	63		★ -...	
Stroke [mm]	1 ... 500				[1]	★ -P	
Cushioning	Elastic cushioning rings/pads at both ends					★ -P	
	Pneumatic cushioning, adjustable at both ends				[2]	★ -PPV	
	Pneumatic cushioning, self-adjusting at both ends				[3]	★ -PPS	
Position sensing	Via proximity switch				[4]	★ -A	-A
Cylinder cap	Lateral supply port, short end cap				[5]	★ -MQ	
	Axial supply port, short end cap				[6]	-MA	
	Mounting flange at front (direct mounting), bearing cap				[7]	-MH	
Piston rod	Through piston rod				[8]	★ -S2	

- [1] -... Longer strokes on request
- [2] PPV Not with MA
- [3] PPS Not with MA, MH, S6, S10, combination MQ-R3 and R8
- [4] A Minimum stroke ≥ 10 mm required for reliable sensing
- [5] MQ Not with S2, S10
- [6] MA Not with S2, S10 R8
- [7] MH Not with combination S6-R3. Not with S10, R8
- [8] S2 Not with S10

 **Note**

The bellows kit DADB must not be used in combination with the variant MH.
The running characteristics change slightly when the bellows kit DADB is combined with the variant S10 or L

 **Note**

Cylinders with position sensing require a minimum stroke of 10 mm to ensure reliable sensing.
Longer strokes on request

Ordering data – Modular product system

Ordering table							
Size	32	40	50	63	Conditions	Code	Enter code
Extended male thread	Extended male piston rod thread						
	[mm]	1 ... 35		1 ... 70	[9]	-...K2	
Shortened male thread	Shortened male piston rod thread						
	[mm]	1 ... 8		1 ... 10	[10]	-...K6	
Female thread	Piston rod with female thread						
		(M6)	(M8)	(M10)	[11]	★ -K3	
Custom thread	Custom thread on the piston rod						
		M10	M12	M16		-“...”K5	
Extended piston rod at one end	Piston rod extended at one end						
	[mm]	1 ... 500				★ ...K8	
Temperature resistance	Heat-resistant seals max. 120°C				[12]	★ -S6	
Constant motion	Slow speed (constant motion at low piston speeds)				[13]	-S10	
Running characteristic	Low friction				[14]	-L	
Corrosion protection	High corrosion protection				[15]	★ -R3	
Scraper	Dust protection				[16]	-R8	
	Increased chemical resistance				[17]	-A1	
	Metal scraper				[18]	-A6	
EU certification	II 2GD				[19]	-EX4	

[9]	K2	Not with K3, K6
[10]	K6	Not with K3
[11]	K3	Not with K5
[12]	S6	Not with S10, S1
[13]	S10	Not with R3, R8, L
[14]	L	Not with MQ, MA, MH, S2, S6, S10
[15]	R8	Not with MA, MH, S10, L, R3, A1, PPS
[16]	R3	Not with R8
[17]	A1	Not with MH, S6, S10, L, R8
[18]	A6	Not with S10, L, MH, P, PPS, S6, R3, EX4
[19]	EX4	Not with S6, S10

Ordering data – Modular product system

Ordering table												
Size	8	10	12	16	20	25	32	40	Conditions	Code	Enter code	
Module no.	8150747	8149443	8149444	8149445	8149446	8149447	8149448	8149449				
Function	Standards-based cylinder, double-acting, based on ISO 6432									DSNU	DSNU	
Piston ø [mm]	8	10	12	16	20	25	32	40		★ -...		
Stroke [mm]	1 ... 100		1 ... 200		1 ... 320		1 ... 500		[1]	★ -...		
Cushioning	Elastic cushioning rings/pads at both ends									★ -P		
	-		-		Pneumatic cushioning, adjustable at both ends					★ -PPV		
	-		-		Pneumatic cushioning, self-adjusting					★ -PPS		
Position sensing	Via proximity switch									★ -A	-A	
Special material properties	None											
	Recommended for production facilities for manufacturing lithium-ion batteries									[2]	-F1A	
Cylinder cap	Standard											
	Lateral supply port, short end cap									[3]	★ -MQ	
	Axial supply port, short end cap									[4]	-MA	
Piston rod	Piston rod at one end											
	Through piston rod									[5]	★ -S2	

- [1] -... Longer strokes on request
- [2] F1A With A only
- [3] MQ Not with PPS
- [4] MA Not with PPV, PPS
- [5] S2 Not with MQ, MA



Note

Cylinders with position sensing require a minimum stroke of 10 mm to ensure reliable sensing.
Longer strokes on request

Ordering data – Modular product system

Ordering table												
Size	8	10	12	16	20	25	32	40	Conditions	Code	Enter code	
Extended male thread	Extended male piston rod thread										[6]	-...K2
	[mm]	1 ... 15		1 ... 20		1 ... 25		1 ... 35				
Shortened male thread	Shortened male piston rod thread										[7]	-...K6
	[mm]	1 ... 4				1 .. 8						
Female thread	Piston rod with female thread										[8]	★ -K3
	-	-	-	-	(M4)	(M6)	(M8)					
Custom thread	Custom thread on the piston rod										[8]	-“...”K5
	-	-	-	-	-	M10	M12					
Extended piston rod at one end	Piston rod extended at one end										[8]	★ -...K8
	[mm]	1 ... 50		1 ... 100		1 ... 110		1 ... 150		1 ... 500		

- [6] K2 Not with K3
 [7] K6 Not with K2, K3
 [8] K5 Not with K3

Datasheet

P cushioning

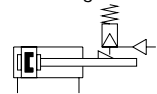

-  - Diameter
8 ... 25 mm
ISO 6432

PPV cushioning

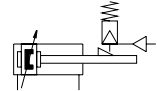

-  - Diameter
32 ... 63 mm

PPS cushioning

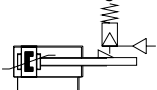

-  - Stroke length
1 ... 500 mm



- - Note

If used in safety-oriented applications, additional measures are necessary, e.g. in Europe the standards listed in the EC Machinery Directive must be observed. Without additional measures in accordance with legally specified minimum requirements, the product is not suitable as a safety-oriented component in control systems.

General technical data

Piston Ø	8	10	12	16	20	25	32	40	50	63
Based on standard	ISO 6432						-			
Pneumatic connection	M5	M5	M5	M5	G1/8	G1/8	G1/8	G1/4	G1/4	G3/8
Piston rod thread	M4	M4	M6	M6	M8	M10x1.25	M10x1.25	M12x1.25	M16x1.5	M16x1.5
Stroke ¹⁾ [mm]	1 ... 100		1 ... 200		1 ... 320	1 ... 500				
Design	Piston/piston rod/cylinder barrel									
Cushioning										
DSNU...-P	Elastic cushioning rings/pads at both ends									
DSNU...-PPV	-		Cushioning, adjustable at both ends							
DSNU...-PPS	-		Cushioning, self-adjusting at both ends							
Cushioning length										
DSNU...-PPV [mm]	-		9	12	15	17	14	18	20	21
DSNU...-PPS [mm]	-		12	15	17	14	18	20	21	
Position sensing	Via proximity switch									
Type of mounting	Via through-hole									
	With accessories									
Mounting position	Any									
Holding force of the clamping unit [N]	80	80	180	180	350	350	600	1000	1400	2000
Axial backlash under load [mm]	0.2		0.3		0.5			0.8		
Pneumatic connection on clamping unit	M5							G1/8		

1) Cylinders with position sensing require a minimum stroke of 10 mm to ensure reliable sensing.
Longer strokes on request

Datasheet

Operating and environmental conditions	
Operating medium	Compressed air to ISO 8573-1:2010 [7:4:4]
Note on the operating/ pilot medium	Lubricated operation possible (in which case lubricated operation will always be required)
Operating pressure	[MPa] 0.3 ... 1
	[bar] 3 ... 10
Ambient temperature	[°C] -10 ... +80
Corrosion resistance class CRC ¹⁾	
DSNU-...	2
DSNU...-R3	3

1) Corrosion resistance class CRC 2 to Festo standard FN 940070

Moderate corrosion stress. Indoor applications in which condensation can occur. External visible parts with primarily decorative surface requirements which are in direct contact with a normal industrial environment.

Corrosion resistance class CRC 3 to Festo standard FN 940070

High corrosion stress. Outdoor exposure under moderate corrosive conditions. Externally visible parts with primarily functional surface requirements which are in direct contact with a normal industrial environment.

Forces [N] and impact energy [J]										
Piston \varnothing	8	10	12	16	20	25	32	40	50	63
Theoretical force at 0.6 MPa (6 bar), advancing	30	47	68	121	189	295	483	753	1178	1870
Theoretical force at 0.6 MPa (6 bar), retracting	23	40	51	104	158	247	415	633	990	1682
Impact energy in the end positions for P cushioning ¹⁾	0.03	0.05	0.07	0.15	0.20	0.30	0.40	0.70	1	1.3

1) The values are reduced by approx. 50% at an ambient temperature of 80°C

Weights [g]										
Piston \varnothing	8	10	12	16	20	25	32	40	50	63
Product weight with 0 mm stroke	97.6	100.3	193	207.9	393.8	456	711.5	1287	2059	2556
Additional weight per 10 mm stroke	2.4	2.7	4	4.6	7.2	11	15.5	24	40	44
Moving mass with 0 mm stroke	7.5	8.5	18.5	23	44	71	121	230	413	459
Moving mass per 10 mm stroke	1	1	2	2	4	6	9	16	25	25

Datasheet

Average piston speed v as a function of payload m in combination with cushioning PPS

Piston \varnothing 16

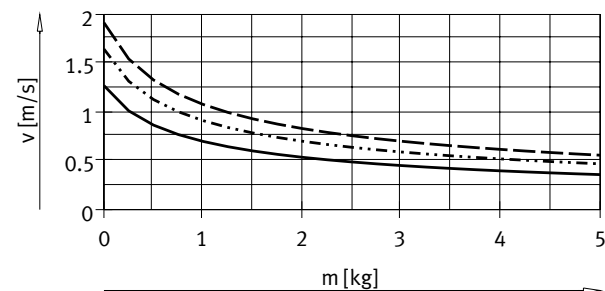

- DSNU-16-50
- ⋯ DSNU-16-100
- - - DSNU-16-200

Piston \varnothing 20

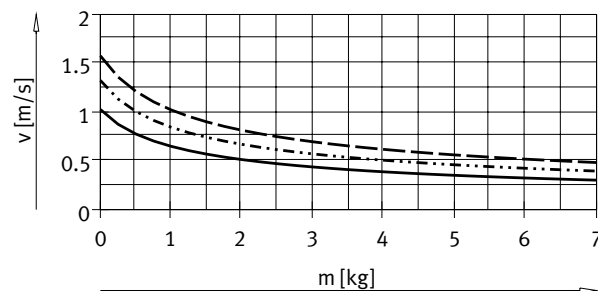

- DSNU-20-50
- ⋯ DSNU-20-100
- - - DSNU-20-200

Piston \varnothing 25

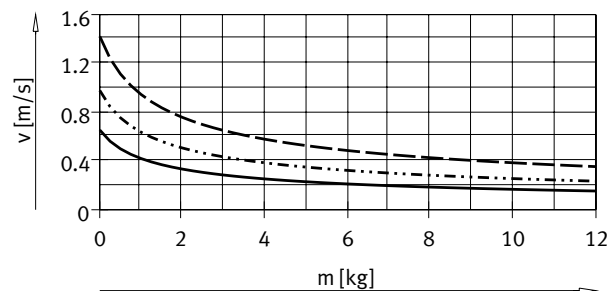

- DSNU-25-50
- ⋯ DSNU-25-100
- - - DSNU-25-200

Piston \varnothing 32

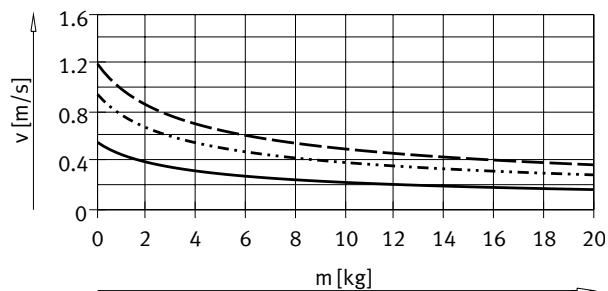

- DSNU-32-50
- ⋯ DSNU-32-100
- - - DSNU-32-200

Piston \varnothing 40

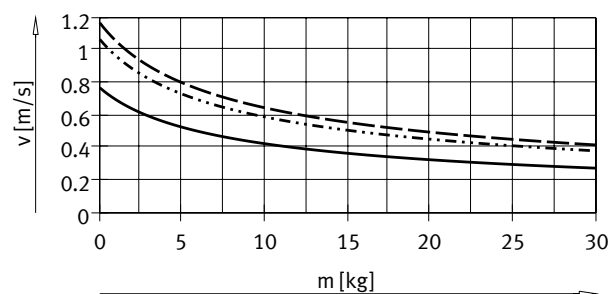

- DSNU-40-50
- ⋯ DSNU-40-100
- - - DSNU-40-200

Piston \varnothing 50

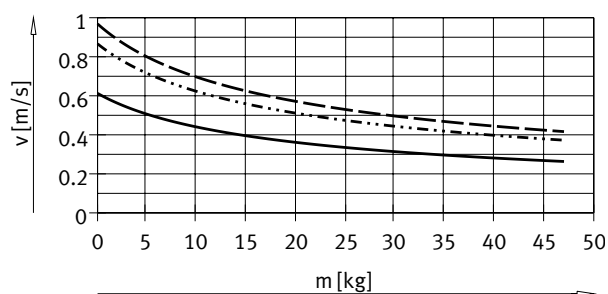

- DSNU-50-50
- ⋯ DSNU-50-100
- - - DSNU-50-200

Datasheet

Average piston speed v as a function of payload m in combination with cushioning PPS

Piston \varnothing 63

Note:

Average piston speed
= Stroke/movement time

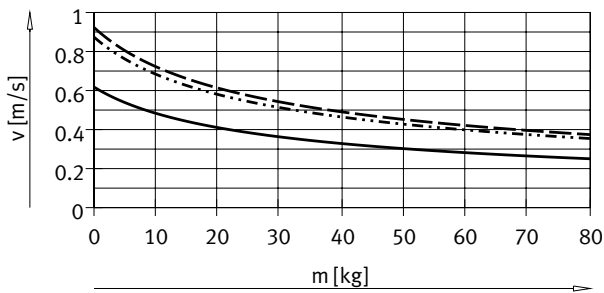

Engineering software for
P cushioning
PPV cushioning
PPS cushioning
→ <https://www.festo.com/x/pneumatic-sizing>

- DSNU-63-50
- DSNU-63-100
- - - DSNU-63-200

Max. transverse force F_q as a function of projection l

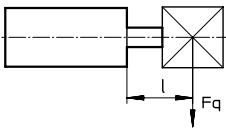

DSNU-...

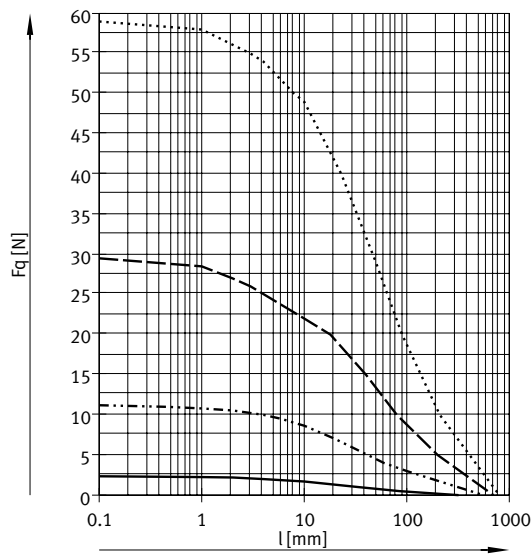

- DSNU-8/10
- DSNU-12/16
- - - DSNU-20
- · - · DSNU-25

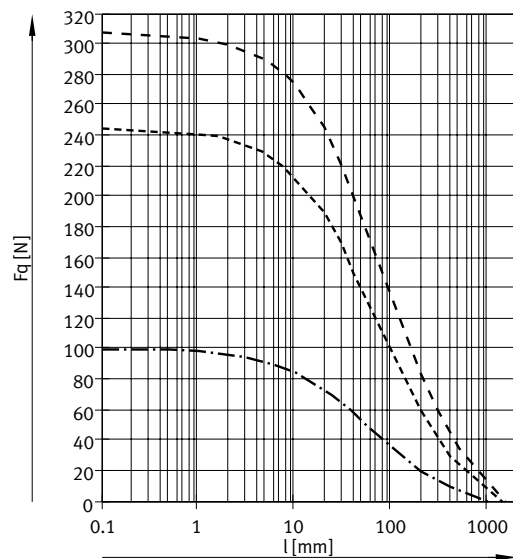

- · - · DSNU-32
- - - DSNU-40
- DSNU-50/63

Datasheet

Max. transverse force F_q as a function of projection l

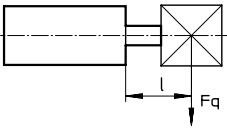

DSNU-...S2 – Through piston rod

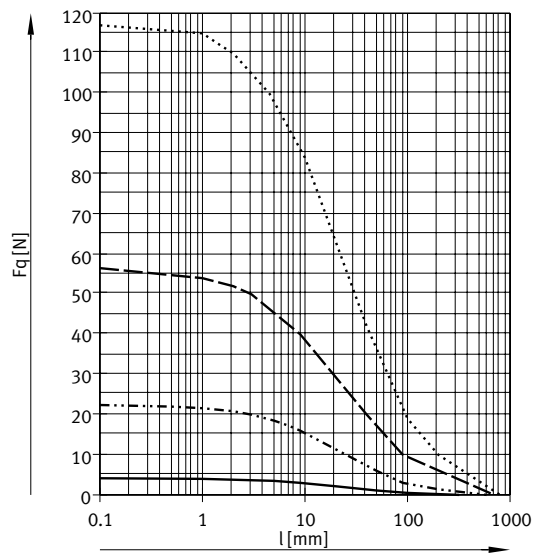

- DSNU-8/10
- - - - - DSNU-12/16
- DSNU-20
- DSNU-25

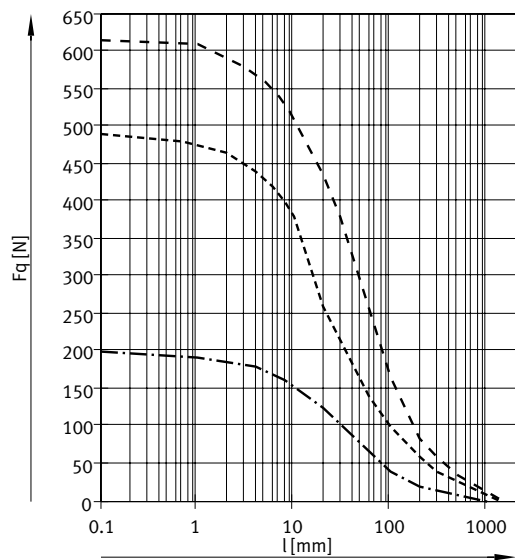

- - - - - DSNU-32
- DSNU-40
- DSNU-50/63

Datasheet

Materials

Sectional view

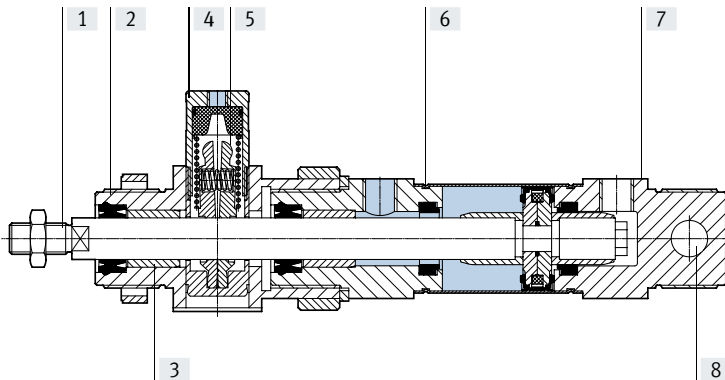

Round cylinder

[1]	Piston rod	
	DSNU-...	High-alloy steel
	DSNU-...-R3	High-alloy stainless steel
[2]	Bearing cap	Anodised aluminium
[3]	Piston rod bearing	Sintered bronze
[4]	Housing, clamping unit	Wrought aluminium alloy
[5]	Clamping jaw	Brass
[6]	Cylinder barrel	High-alloy stainless steel
[7]	End cap	Anodised aluminium
-	Piston, clamping unit	POM
	Spring	Spring steel
	Seals	TPE-U(PU), NBR
	PWIS conformity	VDMA24364-B1/B2-L
	Cleanroom class	Class 6 according to ISO 14644-1
	Note on materials	RoHS-compliant
[8]	Swivel bearing	Polymer

Datasheet

Dimensions

Download CAD data → www.festo.com

DSNU-8 ... 25

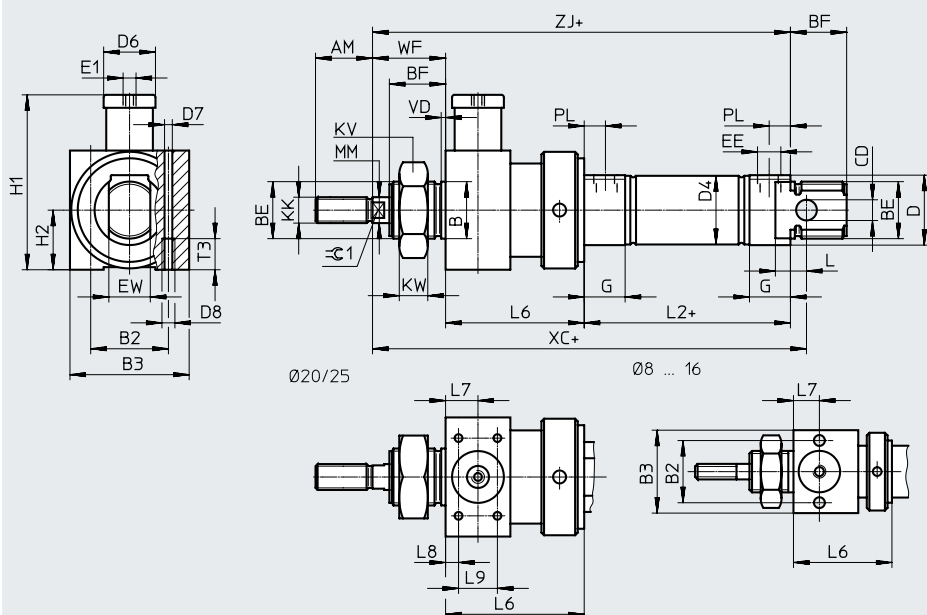

Note
 Piston rod nut is not included in the scope of delivery for diameter 8 ... 20.
 + = plus stroke length

∅ [mm]	AM	B ∅ h8	B2	B3	BE	BF	CD ∅ H9	D ∅	D4 ∅	D6 ∅	D7 ∅	D8
8	12	12	19.5	27	M12x1.25	12	4	16	9.3	12	4.2	M5
10									11.3			
12	16	16	24	32	M16x1.5	17	6	20	13.3			
16									17.3			
20									21.3			
25	22	22	27	36	M22x1.5	22	8	30	26.5	20		

∅ [mm]	E1	EE	EW	G	H1	H2	KK	KV	KW	MM ∅	L	L2
8	M5	M5	8	10	34.5	13.5	M4	19	6	4	6	46
10			12		41	16	M6	24	8	6	9	50
12			16	16	62.5	18	M8	32	11	8	12	68
16		20	16	16	62.5	18	M10x1.25		10	10		69.5
25		G1/8	16	16	16	62.5	18	M8	32	11	10	12

∅ [mm]	L6	L7	L8	L9	T3	PL	VD	WF	XC	ZJ	≈∅1
8	29 ±0.65	8	-	-	11	6	2	±1.2	±1	91	-
10			-	-				16	93	-	
12	38 ±0.75	10	-	-				22	113	110	5
16			-	-				24	120	116	7
20	47 ±0.75	13	4.5	20	8.2	24	142	139	7		
25	48 ±0.75		4.5	20	8.2	28	152	145.5	9		

Datasheet

Dimensions

Download CAD data → www.festo.com

DSNU-8 ... 25

S2 – Through piston rod

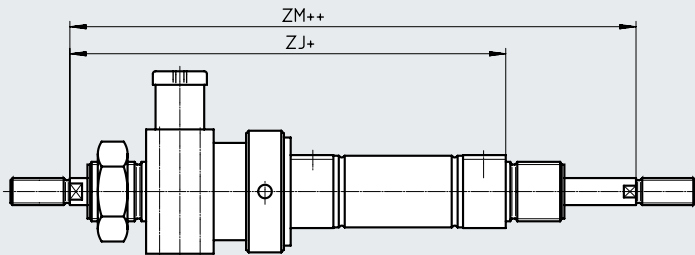

+ = plus stroke length
++ = plus 2x stroke length

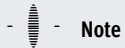

Note

The thread types at both piston rod ends are identical. The clamping unit is mounted at only one end.

In combination with variant Q (→ page 46) the right piston rod is square, the left piston rod round. The clamping unit is mounted on the left-hand, round piston rod.

In combination with variant K8 the piston rod extension is on the right piston rod only. The clamping unit is mounted on the left piston rod that is not extended.

In combination with variant K8 and Q, the piston rod extension is on the right, square piston rod only.

∅ [mm]	ZJ	ZM
8	91	107
10		
12	110	132
16	116	138
20	139	163
25	145.5	173.5

Datasheet

Dimensions

Download CAD data → www.festo.com

DSNU-32 ... 63

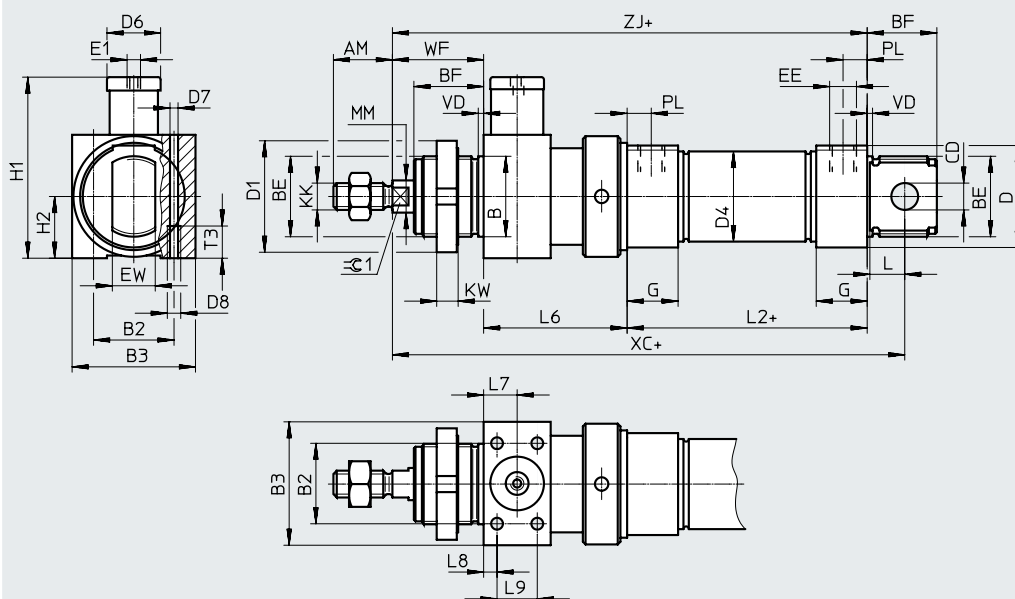

+ = plus stroke length

∅ [mm]	AM	B ∅ h9	B2	B3	BE	BF	CD ∅ H9	D ∅	D1 ∅	D4 ∅	D6 ∅	D7 ∅
32	22	30	30	46	M30x1.5	26	10	41	42	33.6	20	4.4
40	24	38	36	56	M38x1.5	30	12	49	50	41.6	24	6.8
50	32	45	50	65	M45x1.5	33	16	57	60	52.4	30	8.5
63			54	72	M45x1.5			70		65.4	38	

∅ [mm]	D8	E1	EE	EW	G	H1	H2	KK	KW	MM ∅ f8	L	L2
32	M5	M5	G1/8	16	19	67.5	23	M10x1.25	8	12	13	69.5
40	M8	G1/8	G1/4	18	25	89	28	M12x1.25	10	16	15	84.6
50				21		107.5	32.5			20	16	86.2
63	M10	G1/8	G3/8	28	121.5	36	M16x1.5	10	20	16	94.2	

∅ [mm]	L6	L7	L8	L9	T3	PL	VD	WF	XC ±1	ZJ	⊖G1
32	±0.75	12.5	5	15	12	9	2	34	172.5	158.5	10
40	±0.75	17	7	20	18	12	3	39	208.6	192.6	13
50	±0.75	20		26	20			225.2	208.2	17	
63	±0.75	24	8	32	21	13		45	242.2	225.2	17

Datasheet

Dimensions

Download CAD data → www.festo.com

DSNU-32 ... 63

S2 – Through piston rod

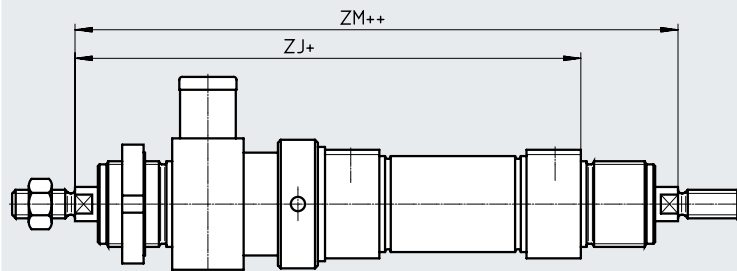

+ = plus stroke length
++ = plus 2x stroke length

 Note

The thread types at both piston rod ends are identical. The clamping unit is mounted at only one end.

In combination with variant Q (→ page 46) the right piston rod is square, the left piston rod round. The clamping unit is mounted on the left-hand, round piston rod.

In combination with variant K8 the piston rod extension is on the right piston rod only. The clamping unit is mounted on the left piston rod that is not extended.

In combination with variant K8 and Q, the piston rod extension is on the right, square piston rod only.

∅ [mm]	ZJ	ZM
32	158.5	192.5
40	192.6	231.6
50	208.2	252.2
63	225.2	270.2

Ordering data – Modular product system

Ordering table									
Size	8	10	12	16	20	25	Conditions	Code	Enter code
Module no.	193986	193987	193988	193989	193990	193991			
Function	Round cylinder, double-acting, based on ISO 6432							DSNU	DSNU
Piston ø [mm]	8	10	12	16	20	25		-...	
Stroke [mm]	1 ... 100		1 ... 200		1 ... 320	1 ... 500	[1]	-...	
Cushioning	Elastic cushioning rings/pads at both ends							-P	
	-		-		Pneumatic cushioning, adjustable at both ends		[2]	-PPV	
	-		-		Pneumatic cushioning, self-adjusting at both ends		[3]	-PPS	
Position sensing	Via proximity switch						[4]	-A	-A
Cylinder cap	Lateral supply port, short end cap						[5]	-MQ	
	Axial supply port, short end cap						[5]	-MA	
Piston rod	Through piston rod							-S2	

- [1] -... Longer strokes on request
 [2] PPV Not with MA
 [3] PPS Not with MA, MH and not with combination MQ-R3
 [4] A Minimum stroke ≥ 10 mm required for reliable sensing
 [5] MQ, MA Not with S2

 **Note**

Cylinders with position sensing require a minimum stroke of 10 mm to ensure reliable sensing.
 Longer strokes on request

Ordering data – Modular product system

Ordering table									
Size	8	10	12	16	20	25	Conditions	Code	Enter code
Extended male thread	Extended male piston rod thread								
	[mm]	1 ... 15	1 ... 20		1 ... 25	1 ... 35	[6]	-...K2	
Shortened male thread	Shortened male piston rod thread								
	[mm]	1 ... 4			1 ... 8	1 ... 10	[7]	-...K6	
Female thread	Piston rod with female thread								
		-	-	-	-	(M4)	(M6)	[8]	-K3
Custom thread	Custom thread on the piston rod								
		-	-	-	-	M10		-“...”K5	
Extended piston rod at one end	Piston rod extended at one end								
	[mm]	1 ... 50	1 ... 100		1 ... 110	1 ... 150		...K8	
Clamping unit	Attached								
								-KP	-KP

[6] K2 Not with K3, K6

[7] K6 Not with K3

[8] K3 Not with K5

Ordering data – Modular product system

Ordering table							
Size	32	40	50	63	Conditions	Code	Enter code
Module no.	193992	193993	193994	193995			
Function	Double-acting round cylinder					DSNU	DSNU
Piston ø [mm]	32	40	50	63		-...	
Stroke [mm]	1 ... 500				[1]	-...	
Cushioning	Elastic cushioning rings/pads at both ends					-P	
	Pneumatic cushioning, adjustable at both ends				[2]	-PPV	
	Pneumatic cushioning, self-adjusting at both ends				[3]	-PPS	
Position sensing	Via proximity switch				[4]	-A	-A
Cylinder cap	Lateral supply port, short end cap				[5]	-MQ	
	Axial supply port, short end cap				[5]	-MA	
Piston rod	Through piston rod					-S2	

- [1] -... Longer strokes on request
 [2] PPV Not with MA
 [3] PPS Not with MA, MH and not with combination MQ-R3
 [4] A Minimum stroke ≥ 10 mm required for reliable sensing
 [5] MQ, MA Not with S2

 **Note**

Cylinders with position sensing require a minimum stroke of 10 mm to ensure reliable sensing.
 Longer strokes on request

Ordering data – Modular product system

Ordering table									
Size	32	40	50	63	Conditions	Code	Enter code		
Extended male thread	Extended male piston rod thread								
	[mm]	1 ... 35		1 ... 70		[6]	-...K2		
Shortened male thread	Shortened male piston rod thread								
	[mm]	1 ... 8		1 ... 10		[7]	-...K6		
Female thread	Piston rod with female thread								
		(M6)	(M8)	(M10)		[8]	-K3		
Custom thread	Custom thread on the piston rod								
		M10	M12	M16			-“...”K5		
Extended piston rod at one end	Piston rod extended at one end								
	[mm]	1 ... 500							...K8
Clamping unit	Attached								-KP

- [6] K2 Not with K3, K6
- [7] K6 Not with K3
- [8] K3 Not with K5

Round cylinders DSNU-Q, protected against rotation

Datasheet

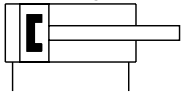

P cushioning

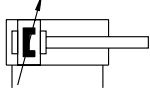

-  Diameter
12 ... 25 mm
ISO 6432

PPV cushioning



-  Diameter
32 ... 63 mm
-  Stroke length
1 ... 500 mm



General technical data								
Piston \varnothing	12	16	20	25	32	40	50	63
Based on standard	ISO 6432				–			
Pneumatic connection	M5	M5	G1/8	G1/8	G1/8	G1/4	G1/4	G3/8
Piston rod thread	M6	M6	M8	M10x1.25	M10x1.25	M12x1.25	M16x1.5	M16x1.5
Stroke ¹⁾ [mm]	1 ... 160		1 ... 200	1 ... 250	1 ... 300	1 ... 400		1 ... 500
Design	Piston Protected against rotation with square piston rod							
Max. torque at the piston rod [Nm]	0.10	0.10	0.20	0.45	0.8	1.1	1.5	1.5
Cushioning								
DSNU-...-P	Elastic cushioning rings/pads at both ends	–			Elastic cushioning rings/pads at both ends			
DSNU-...-PPV	–	Pneumatic cushioning, adjustable at both ends						
Cushioning length (PPV) [mm]	–	12	15	17	14	18	20	21
Position sensing	Via proximity switch							
Type of mounting	With accessories							
Mounting position	Any							

- 1) Cylinders with position sensing require a minimum stroke of 10 mm to ensure reliable sensing.
Longer strokes on request

Operating and environmental conditions								
	12	16	20	25	32	40	50	63
Operating medium	Compressed air to ISO 8573-1:2010 [7:4:4]							
Note on the operating/pilot medium	Lubricated operation possible (in which case lubricated operation will always be required)							
Operating pressure								
DSNU-... [MPa]	0.15 ... 1 ¹⁾		0.1 ... 1					
[bar]	1.5 ... 10 ¹⁾		1 ... 10					
DSNU-Q-...-S6 [MPa]	–				0.1 ... 0.8			
[bar]	–				1 ... 8			
Ambient temperature ²⁾								
DSNU-... [°C]	–20 ... +80							
DSNU-Q-...-S6 [°C]	–				0 ... +120			
Corrosion resistance class CRC ³⁾								
DSNU-... [MPa]	2							
DSNU-Q-...-R3	3							

- 1) For DSNU-12-...-Q-PPV (pneumatic cushioning adjustable at both ends): 0.2 ... 1 MPa (2 ... 10 bar)
 2) Note operating range of proximity switches
 3) Corrosion resistance class CRC 2 to Festo standard FN 940070
 Moderate corrosion stress. Indoor applications in which condensation can occur. External visible parts with primarily decorative surface requirements which are in direct contact with a normal industrial environment.
 Corrosion resistance class CRC 3 to Festo standard FN 940070
 High corrosion stress. Outdoor exposure under moderate corrosive conditions. Externally visible parts with primarily functional surface requirements which are in direct contact with a normal industrial environment.

Datasheet

ATEX ¹⁾	
ATEX category for gas	II 2G
Type of ignition protection for gas	cT4
ATEX category for dust	II 2D
Type of ignition protection for dust	c 120°C
Explosion-proof ambient temperature	-20°C ≤ Ta ≤ +60°C
CE marking (see declaration of conformity)	To EU Explosion Protection Directive (ATEX)
UKCA marking (see declaration of conformity)	To UK EX instructions
Explosion protection certification outside the EU	EPL Db (GB) EPL Gb (GB)

1) Note the ATEX certification of the accessories.

Forces [N] and impact energy [J]								
Piston ø	12	16	20	25	32	40	50	63
Theoretical force at 0.6 MPa (6 bar), advancing	68	121	189	295	483	753	1178	1870
Theoretical force at 0.6 MPa (6 bar), retracting	51	104	158	247	415	633	990	1682
Impact energy in the end positions for P cushioning ¹⁾	0.07	0.15	0.20	0.30	0.40	0.70	1	1.3

1) The values are reduced by approx. 50% at an ambient temperature of 80°C

Weights [g]								
Piston ø	12	16	20	25	32	40	50	63
Product weight with 0 mm stroke	80	110	215	275	370.5	661	1087	1445
Additional weight per 10 mm stroke	4.1	4.7	7.1	10.9	15.5	24	40	44
Moving mass with 0 mm stroke	18.5	23	44	71	121	230	413	459
Moving mass per 10 mm stroke	2	2	4	6	9	16	25	25

Materials

Sectional view

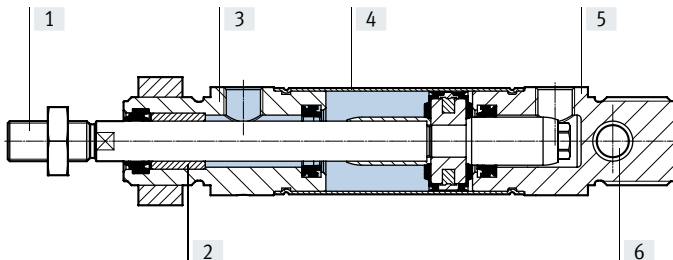

Round cylinder	
[1] Piston rod	
DSNU-...	High-alloy steel
DSNU-...-R3	High-alloy stainless steel
[2] Piston rod bearing	Sintered bronze
[3] Bearing cap	Anodised aluminium
[4] Cylinder barrel	High-alloy stainless steel
[5] End cap	Anodised aluminium
- Seals	TPE-U(PU), NBR
PWS conformity	VDMA24364-B1/B2-L
Cleanroom class	Class 6 according to ISO 14644-1
Note on materials	RoHS-compliant
[6] Swivel bearing	Polymer

Datasheet

Dimensions

Download CAD data → www.festo.com

DSNU-12 ... 25

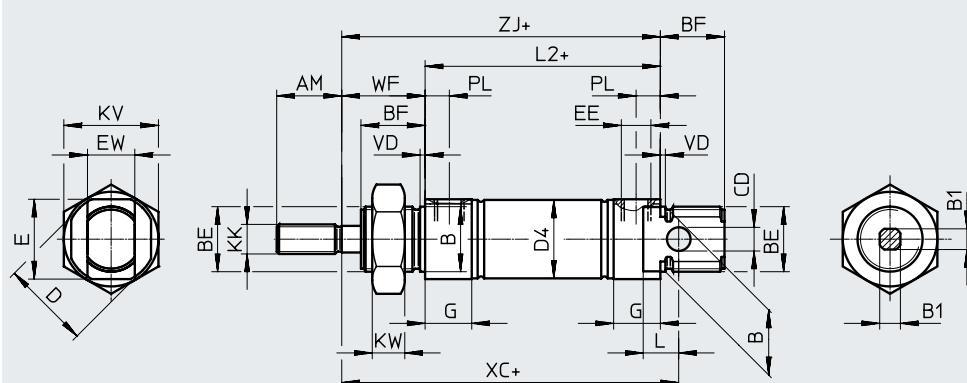

- - **Note**
 Piston rod nut is not included in the scope of delivery for diameter 12 ... 20.
 + = plus stroke length

∅	AM	B ∅ h8	B1	BE	BF	CD ∅ H9	D ∅	D4 ∅	E	EE	EW
12	16	16	5.5	M16x1.5	17	6	20	13.3	18	M5	12
16								17.3			
20	20	22	7	M22x1.5	20	8	30	21.3	26	G1/8	16
25	22		9		22			26.5			

∅	G	KK	KV	KW	L	L2	PL	VD	WF ±1.2	XC ±1	ZJ
12	10	M6	24	8	9	50	6	2	22	75	72
16						56					
20	16	M8	32	11	12	68	8.2	24	95	92	
25		M10x1.25				28					104

S2 – Through piston rod

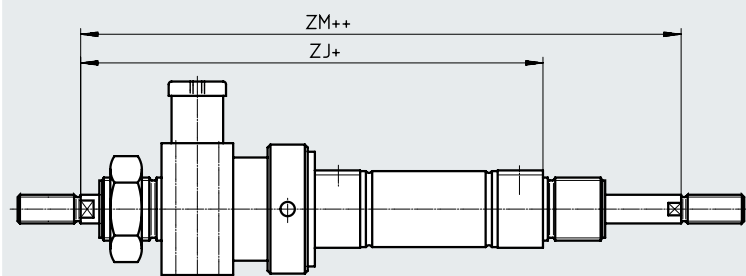

- - **Note**
 The thread types at both piston rod ends are identical. The clamping unit is mounted at only one end. In combination with variant Q, the right piston rod is square, the left piston rod round. The clamping unit is mounted on the left-hand, round piston rod.
 + = plus stroke length
 ++ = plus 2x stroke length

∅ [mm]	ZJ	ZM
12	110	132
16	116	138
20	139	163
25	145.5	173.5

Datasheet

Dimensions

Download CAD data → www.festo.com

DSNU-32 ... 63

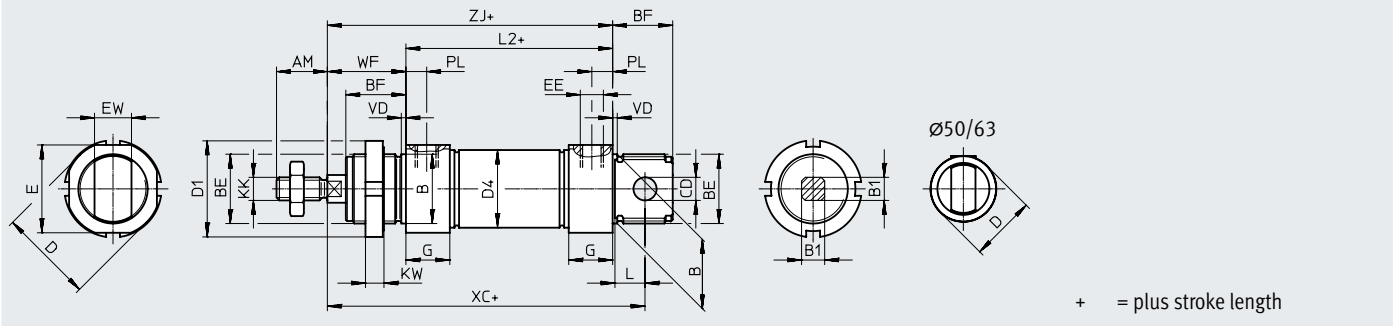

∅	AM	B ∅ h8	B1	BE	BF	CD ∅ H9	D ∅	D1 ∅	D4 ∅	E	EE	EW
32	22	30	10	M30x1.5	26	10	41	42	33.6	38	G1/8	16
40	24	38	12	M38x1.5	30	12	49	50	41.6	45	G1/4	18
50	32	45	16	M45x1.5	33	16	57	60	52.4	-	G1/4	21
63	32	45	16	M45x1.5	33	16	70	60	65.4	-	G3/8	21

∅	G	KK	KW	L	L2	PL	VD	WF ±1.2	XC ±1	ZJ
32	19	M10x1.25	8	13	69.5	9	2	34	117.5	103.5
40	25	M12x1.25	10	15	84.6	12	3	39	139.6	123.6
50	25	M16x1.5	10	16	86.2	12	3	44	147.2	130.2
63	28	M16x1.5	10	16	94.2	13	3	45	156.2	139.2

S2 – Through piston rod

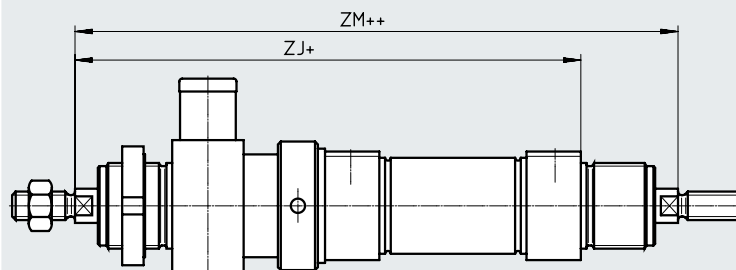

Note

The thread types at both piston rod ends are identical. The clamping unit is mounted at only one end. In combination with variant Q, the right piston rod is square, the left piston rod round. The clamping unit is mounted on the left-hand, round piston rod.

+ = plus stroke length
++ = plus 2x stroke length

∅	ZJ	ZM
32	158.5	192.5
40	192.6	231.6
50	208.2	252.2
63	225.2	270.2

Ordering data – Modular product system

Ordering table							
Size	12	16	20	25	Conditions	Code	Enter code
Module no.	193988	193989	193990	193991			
Function	Round cylinder, double-acting, based on ISO 6432					DSNU	DSNU
Piston ø [mm]	12	16	20	25		★ -...	
Stroke [mm]	1 ... 160		1 ... 200	1 ... 250	[1]	★ -...	
Cushioning	Elastic cushioning rings/pads at both ends	–	–	–		★ -P	
	–	Pneumatic cushioning, adjustable at both ends			[2]	★ -PPV	
Position sensing	Via proximity switch				[3]	★ -A	-A
Cylinder cap	Lateral supply port, short end cap				[4]	★ -MQ	
	Axial supply port, short end cap	–	–	–	[4]	-MA	
	–	With mounting flange at front (direct mounting), bearing cap			[5]	-MH	
Protection against rotation	Square piston rod					★ -Q	-Q
Piston rod	Through piston rod					★ -S2	

- [1] -... Longer strokes on request
- [2] PPV Not with MA
- [3] A Minimum stroke ≥ 10 mm required for reliable sensing
- [4] MQ, MA Not with S2
- [5] MH Not with combination Q-R3



Note

The bellows kit DADB must not be used in combination with the variant Q.



Note

Cylinders with position sensing require a minimum stroke of 10 mm to ensure reliable sensing.
Longer strokes on request

Ordering data – Modular product system

Ordering table							
Size	12	16	20	25	Conditions	Code	Enter code
Extended male thread	Extended male piston rod thread						
	[mm]	1 ... 20	1 ... 25	1 ... 35	[6]	-...K2	
Shortened male thread	Shortened male piston rod thread						
	[mm]	1 ... 4	1 ... 8	1 ... 10	[7]	-...K6	
Female thread	Piston rod with female thread						
		-	(M4)	(M6)	[8]	★ -K3	
Custom thread	Custom thread on the piston rod						
		-	-	M10		-“...”K5	
Extended piston rod at one end	Piston rod extended at one end						
	[mm]	1 ... 100	1 ... 110	1 ... 150		★ ...K8	
Clamping unit	Attached				[9]	-KP	
Corrosion protection	-	High corrosion protection				★ -R3	
EU certification	II 2GD				[10]	-EX4	

[6]	K2	Not with K3, K6
[7]	K6	Not with K3
[8]	K3	Not with K5
[9]	KP	Only with S2. Not with R3
[10]	EX4	Not with KP

Ordering data – Modular product system

Ordering table							
Size	32	40	50	63	Conditions	Code	Enter code
Module no.	193992	193993	193994	193995			
Function	Double-acting round cylinder					DSNU	DSNU
Piston ø [mm]	32	40	50	63		★ -...	
Stroke [mm]	1 ... 300	1 ... 400		1 ... 500	[1]	★ -P	
Cushioning	Elastic cushioning rings/pads at both ends					★ -P	
	Pneumatic cushioning, adjustable at both ends				[2]	★ -PPV	
Position sensing	Via proximity switch				[3]	★ -A	-A
Cylinder cap	Lateral supply port, short end cap				[4]	★ -MQ	
	Axial supply port, short end cap				[4]	-MA	
	Mounting flange at front (direct mounting), bearing cap				[5]	-MH	
Protection against rotation	Square piston rod					★ -Q	-Q
Piston rod	Through piston rod					★ -S2	

- [1] -... Longer strokes on request
- [2] PPV Not with MA
- [3] A Minimum stroke ≥ 10 mm required for reliable sensing
- [4] MQ, MA Not with S2
- [5] MH Not with combinations: Q-R3, S6-R3. Not with KP



Note

The bellows kit DADB must not be used in combination with the variant Q.



Note

Cylinders with position sensing require a minimum stroke of 10 mm to ensure reliable sensing. Longer strokes on request

Ordering data – Modular product system

Ordering table		32	40	50	63	Conditions	Code	Enter code
Extended male thread		Extended male piston rod thread						
	[mm]	1 ... 35		1 ... 70		[6]	-...K2	
Shortened male thread		Shortened male piston rod thread						
	[mm]	1 ... 8		1 ... 10		[7]	-...K6	
Female thread		Piston rod with female thread						
		(M6)	(M8)	(M10)		[8]	★ -K3	
Custom thread		Custom thread on the piston rod						
		M10	M12	M16			-“...”K5	
Extended piston rod at one end		Piston rod extended at one end						
	[mm]	1 ... 500					★ ...K8	
Clamping unit		Attached				[9]	-KP	
Temperature resistance		Heat-resistant seals max. 120°C					★ -S6	
Corrosion protection		High corrosion protection					★ -R3	
EU certification		II 2GD				[10]	-EX4	

[6]	K2	Not with K3, K6
[7]	K6	Not with K
[8]	K3	Not with K5
[9]	KP	Only with S2. Not with S6, R3
[10]	EX4	Not with KP, S6

Accessories

Foot mounting HBN/CRHBN

Scope of delivery:

HBN/CRHBN-...x1: 1 foot

HBN/CRHBN-...x2: 2 feet and 1 nut

Material:

HBN: Galvanised steel

CRHBN: High-alloy stainless steel

RoHS-compliant

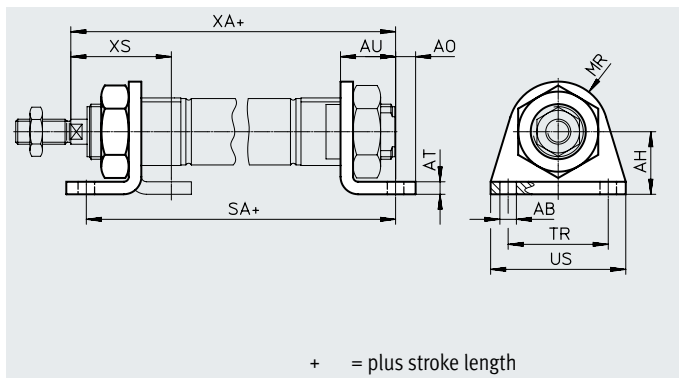

Dimensions and ordering data

For \varnothing [mm]	AB \varnothing	AH	AO	AT	AU	R1	SA		TR	US	XA		XS	
								DSNU-KP				DSNU-KP		DSNU-KP
8, 10	4.5	16	5	3	11	10	68	97	25	35	73	102	24	-
12	5.5	20	6	4	14	13	78	116	32	42	86	124	32	-
16	5.5	20	6	4	14	13	84	122	32	42	92	130	32	-
20	6.6	25	8	5	17	20	102	149	40	54	109	156	36	-
25	6.6	25	8	5	17	20	103.5	151.5	40	54	114.5	162.5	40	-

For \varnothing [mm]	Basic version				High corrosion protection			
	CRC ¹⁾	Weight [g]	Part no.	Type	CRC ¹⁾	Weight [g]	Part no.	Type
8, 10	1	22	5123	HBN-8/10x1	-	-	-	
	1	54	5124	HBN-8/10x2	-	-	-	
12, 16	1	43	★ 5125	HBN-12/16x1	4	43	161866	CRHBN-12/16x1
	1	107	★ 5126	HBN-12/16x2	4	107	162999	CRHBN-12/16x2
20, 25	1	95	★ 5127	HBN-20/25x1	4	94	161867	CRHBN-20/25x1
	1	237	★ 5128	HBN-20/25x2	4	236	162998	CRHBN-20/25x2

1) Corrosion resistance class CRC 1 to Festo standard FN 940070

Low corrosion stress. Dry internal application or transport and storage protection. Also applies to parts behind covers, in the non-visible interior area, or parts which are covered in the application (e.g. drive trunnions).

Corrosion resistance class CRC 4 to Festo standard FN 940070

Particularly high corrosion stress. Outdoor exposure under extreme corrosive conditions. Parts exposed to aggressive media, e.g. in the chemical or food industries. Such applications may need to be safeguarded by means of special testing (→ also FN 940082), using appropriate media.

Accessories

Foot mounting HBN/CRH

Material:

HBN: Galvanised steel

CRH: High-alloy stainless steel

RoHS-compliant

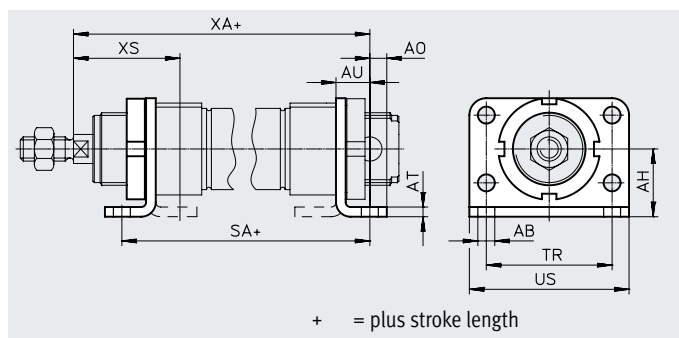

Dimensions and ordering data

For \varnothing [mm]	AB \varnothing	AH	AO	AT	AU	SA		TR	US	XA		XS	
							DSNU-KP				DSNU-KP		DSNU-KP
32	7	28	7	4	14	97.5	151	52	66	117.5	171	44	–
40	9	33	10	5	20	124.6	192.1	60	80	143.6	206.1	54	–
50	9	40	10	6	20	126.2	202.7	70	90	150.2	226.7	58	–
63	9	45	10	6	20	134.2	218.7	76	96	159.2	243.7	59	–

For \varnothing [mm]	Basic version				High corrosion protection			
	CRC ¹⁾	Weight [g]	Part no.	Type	CRC ¹⁾	Weight [g]	Part no.	Type
32	1	353	195851	HBN-32x2	4	353	162951	CRH-32
40	1	611	195852	HBN-40x2	4	611	162952	CRH-40
50	1	916	195853	HBN-50x2	4	916	162953	CRH-50
63	1	1066	195854	HBN-63x2	4	1066	162954	CRH-63

1) Corrosion resistance class CRC 1 to Festo standard FN 940070

Low corrosion stress. Dry internal application or transport and storage protection. Also applies to parts behind covers, in the non-visible interior area, or parts which are covered in the application (e.g. drive trunnions).

Corrosion resistance class CRC 4 to Festo standard FN 940070

Particularly high corrosion stress. Outdoor exposure under extreme corrosive conditions. Parts exposed to aggressive media, e.g. in the chemical or food industries. Such applications may need to be safeguarded by means of special testing (→ also FN 940082), using appropriate media.

Accessories

Flange mounting FBN/CRFBN

Material:
 FBN: Galvanised steel
 CRFBN: High-alloy stainless steel

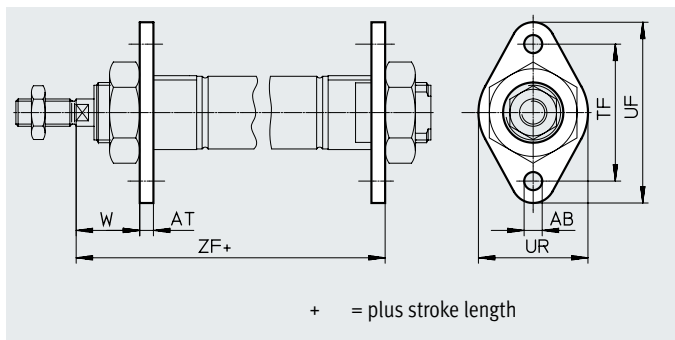

Dimensions and ordering data								
For \varnothing [mm]	AB \varnothing	AT	TF	UF	UR	W	ZF	
								DSNU-KP
8, 10	4.5	3	30	40	25	13	65	94
12	5.5	4	40	53	30	18	76	114
16	5.5	4	40	53	30	18	82	120
20	6.6	5	50	66	40	19	97	144
25	6.6	5	50	66	40	23	102.5	150.5

For \varnothing [mm]	Basic version				High corrosion protection			
	CRC ¹⁾	Weight [g]	Part no.	Type	CRC ¹⁾	Weight [g]	Part no.	Type
8, 10	1	12	5129	FBN-8/10	–	–	–	–
12, 16	1	26	5130	FBN-12/16	4	26	161864	CRFBN-12/16
20, 25	1	52	5131	FBN-20/25	4	52	161865	CRFBN-20/25

1) Corrosion resistance class CRC 1 to Festo standard FN 940070
 Low corrosion stress. Dry internal application or transport and storage protection. Also applies to parts behind covers, in the non-visible interior area, or parts which are covered in the application (e.g. drive trunnions).
 Corrosion resistance class CRC 4 to Festo standard FN 940070
 Particularly high corrosion stress. Outdoor exposure under extreme corrosive conditions. Parts exposed to aggressive media, e.g. in the chemical or food industries. Such applications may need to be safeguarded by means of special testing (→ also FN 940082), using appropriate media.

Accessories

Flange mounting FBN/CRFV

Material:

FBN: Galvanised steel

CRFV: High-alloy stainless steel

RoHS-compliant

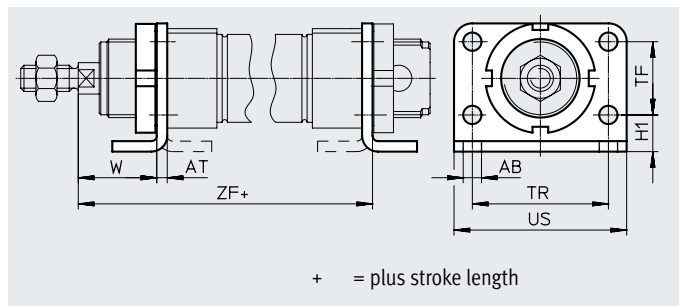

Dimensions and ordering data

For \varnothing	AB \varnothing	AT	H1	TF	TR	US	W	ZF	
[mm]							± 1.2		DSNU-KP
32	7	4	14	28	52	66	30	107.5	161
40	9	5	18	30	60	80	29	128.6	191.1
50	9	6	20	40	70	90	38	136.2	212.6
63	9	6	20	50	76	96	39	145.2	229.7

For \varnothing [mm]	Basic version				High corrosion protection			
	CRC ¹⁾	Weight [g]	Part no.	Type	CRC ¹⁾	Weight [g]	Part no.	Type
32	1	103	195855	FBN-32	4	103	161858	CRFV-32
40	1	191	195856	FBN-40	4	191	161859	CRFV-40
50	1	292	195857	FBN-50	4	292	161860	CRFV-50
63	1	367	195858	FBN-63	4	367	161861	CRFV-63

1) Corrosion resistance class CRC 1 to Festo standard FN 940070

Low corrosion stress. Dry internal application or transport and storage protection. Also applies to parts behind covers, in the non-visible interior area, or parts which are covered in the application (e.g. drive trunnions).

Corrosion resistance class CRC 4 to Festo standard FN 940070

Particularly high corrosion stress. Outdoor exposure under extreme corrosive conditions. Parts exposed to aggressive media, e.g. in the chemical or food industries. Such applications may need to be safeguarded by means of special testing (→ also FN 940082), using appropriate media.

Accessories

Swivel mounting SBN

Material:
 Retaining ring: Anodised wrought aluminium alloy
 Bearing: Bronze
 Screws: Galvanised steel
 Bracket: Steel
 Cannot be used on the bearing cap in combination with bellows kit DADB.

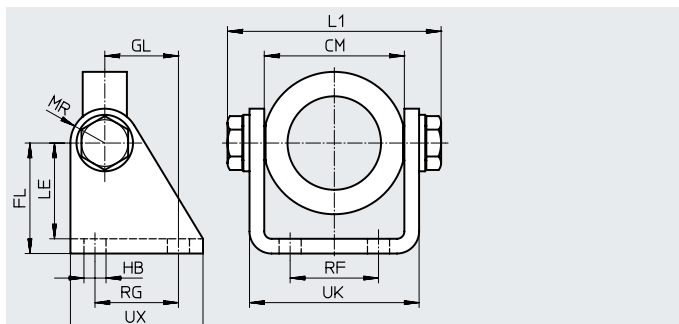

Dimensions and ordering data

For \varnothing [mm]	CM	FL	GL	HB	L1 max.	LE	MR	RF	RG	UK	UX	CRC ¹⁾	Weight [g]	Part no.	Type
20/25	38.1+0.4	35	20	7	60.2	31	12	20	24	46.1	40	1	238	539927	SBN-20/25
32	46.1+0.2	40	27	9	72.2	35	13	28	30	56.1	50	1	361	539924	SBN-32
40	57.1+0.2	45	30	9	88.2	39	14	36	34	69.1	54	1	593	539925	SBN-40
50/63	70.1+0.4	50	34	9	102.2	44	16	42	35	82.1	65	1	894	539926	SBN-50/63

1) Corrosion resistance class CRC 1 to Festo standard FN 940070
 Low corrosion stress. Dry internal application or transport and storage protection. Also applies to parts behind covers, in the non-visible interior area, or parts which are covered in the application (e.g. drive trunnions).

Swivel mounting WBN

Material:
 Galvanised steel
 RoHS-compliant
 Cannot be used on the bearing cap in combination with bellows kit DADB.

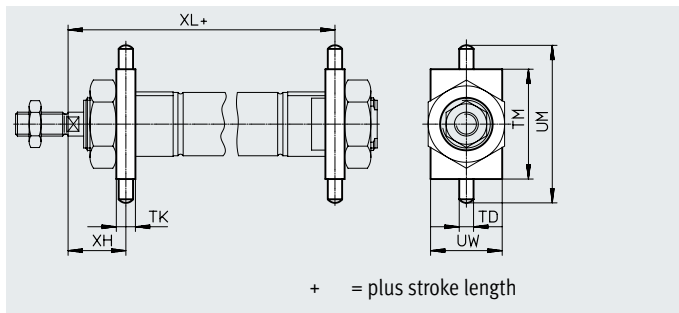
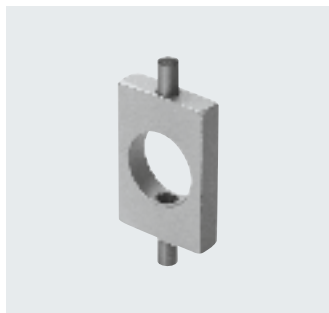

Dimensions and ordering data

For \varnothing [mm]	TD \varnothing -0.01/ -0.05	TK	TM	UM	UW	XH	XL		CRC ¹⁾	Weight [g]	Part no.	Type
								DSNU-KP				
8, 10	4	6	26	38	20	13	65	94	1	20	8608	WBN-8/10
12	6	8	38	58	25	18	76	114	1	51	8609	WBN-12/16
16	6	8	38	58	25	18	82	120	1	51	8609	WBN-12/16
20	6	8	46	66	30	20	96	143	1	67	8610	WBN-20/25
25	6	8	46	66	30	24	101.5	149.5	1	67	8610	WBN-20/25
32	8	12	50	76	40	28	109.5	163	1	131	195863	WBN-32
40	10	15	60	92	50	31.5	126.1	193.6	1	238	195864	WBN-40
50	12	20	80	116	65	34	140.2	216.7	1	596	195865	WBN-50/63
63	12	20	80	116	65	35	149.2	233.7	1	596	195865	WBN-50/63

1) Corrosion resistance class CRC 1 to Festo standard FN 940070
 Low corrosion stress. Dry internal application or transport and storage protection. Also applies to parts behind covers, in the non-visible interior area, or parts which are covered in the application (e.g. drive trunnions).

Accessories

Clevis foot LBN/CRLBN

Material:

LBN: galvanised steel

CRLBN: High-alloy stainless steel

RoHS-compliant

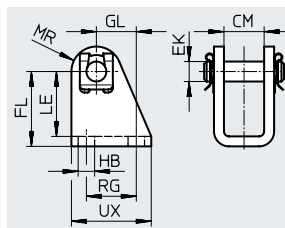

Dimensions and ordering data

For \varnothing [mm]	CM	EK \varnothing	FL	GL	HB	LE	MR	RG	UX
8, 10	8.1	4	24 +0.3/-0.2	13.8	4.5	21.5	5	12.5	20
12, 16	12.1	6	27 +0.3/-0.2	13	5.5	24	7	15	25
20, 25	16.1	8	30 +0.4/-0.2	16	6.6	26	10	20	32
32	16.1	10	35 +0.4/-0.2	18.5	6.6	31	11	24	35
40	18.1	12	40 +0.4/-0.2	24.5	9	35	13	30	45
50, 63	21.1	16	45 +0.5/-0.2	28	9	39	14	34	50

For \varnothing [mm]	Basic version				High corrosion protection			
	CRC ¹⁾	Weight [g]	Part no.	Type	CRC ¹⁾	Weight [g]	Part no.	Type
8, 10	1	20	6057	LBN-8/10	–	–	–	–
12, 16	1	40	★ 6058	LBN-12/16	4	39	161862	CRLBN-12/16
20, 25	1	84	★ 6059	LBN-20/25	4	82	161863	CRLBN-20/25
32	1	110	195860	LBN-32	4	106	195866	CRLBN-32
40	1	191	195861	LBN-40	4	185	195867	CRLBN-40
50, 63	1	300	195862	LBN-50/63	4	283	195868	CRLBN-50/63

1) Corrosion resistance class CRC 1 to Festo standard FN 940070

Low corrosion stress. Dry internal application or transport and storage protection. Also applies to parts behind covers, in the non-visible interior area, or parts which are covered in the application (e.g. drive trunnions).

Corrosion resistance class CRC 4 to Festo standard FN 940070



Particularly high corrosion stress. Outdoor exposure under extreme corrosive conditions. Parts exposed to aggressive media, e.g. in the chemical or food industries. Such applications may need to be safeguarded by means of special testing (→ also FN 940082), using appropriate media.

Accessories

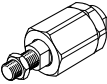
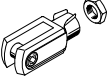
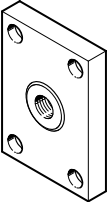
Ordering data – Piston rod attachments

Designation	For ø	Part no.	Type
Rod eye SGS			
	8	9253	SGS-M4
	10		
	12	★ 9254	SGS-M6
	16		
	20	★ 9255	SGS-M8
	25	★ 9261	SGS-M10x1.25
	32		
	40	★ 9262	SGS-M12x1.25
	50	★ 9263	SGS-M16x1.5
63			
Self-aligning rod coupler FK			
	8	6528	FK-M4
	10		
	12	★ 2061	FK-M6
	16		
	20	★ 2062	FK-M8
	25	★ 6140	FK-M10x1.25
	32		
	40	★ 6141	FK-M12x1.25
	50	★ 6142	FK-M16x1.5
63			
Rod clevis SG			
	8	6532	SG-M4
	10		
	12	★ 3110	SG-M6
	16		
	20	★ 3111	SG-M8
	25	★ 6144	SG-M10x1.25
	32		
	40	★ 6145	SG-M12x1.25
	50	★ 6146	SG-M16x1.5
63			
Coupling piece KSZ			
	12	36123	KSZ-M6
	16		
	20	36124	KSZ-M8
	25	36125	KSZ-M10x1.25
	32		
	40	36126	KSZ-M12x1.25
	50	36127	KSZ-M16x1.5
	63		

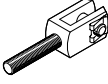
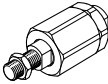
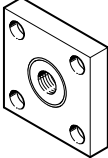
Datasheets → Internet: piston rod attachment

Designation	For ø	Part no.	Type
Rod clevis SGA			
	8		
	10		
	12		
	16		
	20		
	25		
	32	32954	SGA-M10x1.25
	40	10767	SGA-M12x1.25
	50	10768	SGA-M16x1.5
63			
Self-aligning rod coupler DARP			
	8	8170110	DARP-M4-F
	10		
	12	8170115	DARP-M6-F
	16		
	20	8170116	DARP-M8-F
	25	8170119	DARP-M10P-F
	32		
	40	8170120	DARP-M12P-F
	50	8170121	DARP-M16P-F
63			
Coupling piece KSG			
	8		
	10		
	12		
	16		
	20		
	25	32963	KSG-M10x1.25
	32		
	40	32964	KSG-M12x1.25
	50	32965	KSG-M16x1.5
63			
Hex nut MSK			
	16	189007	MSK-M16x1.5
	20	★ 189009	MSK-M22x1.5
	25		

Accessories

Ordering data – Piston rod attachments, corrosion-resistant

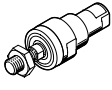
Designation	For ø	Part no.	Type
Rod eye CRSGS			
	12	195580	CRSGS-M6
	16		
	20	195581	CRSGS-M8
	25		
	32	195582	CRSGS-M10x1.25
	40		
	50	195583	CRSGS-M12x1.25
	63	195584	CRSGS-M16x1.5
Self-aligning rod coupler CRFK			
	25	2305778	CRFK-M10x1.25
	32		
	40	2305779	CRFK-M12x1.25
	50	2490673	CRFK-M16x1.5
	63		

Datasheets → Internet: piston rod attachment

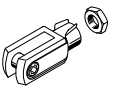
Designation	For ø	Part no.	Type
Rod clevis CRSG			
	8	8165295	CRSG-M4
	12	13567	CRSG-M6
	16		
	20	13568	CRSG-M8
	25	13569	CRSG-M10x1.25
	32		
	40	13570	CRSG-M12x1.25
	50	13571	CRSG-M16x1.5
	63		

Ordering data – Mounting components

Designation	For ø	Part no.	Type
Clevis foot LBG			
	32	31761	LBG-32
	40	31762	LBG-40
	50	31763	LBG-50
	63	31764	LBG-63

Datasheets → Internet: clevis foot

Designation	For ø	Part no.	Type
Right angle clevis foot LQG			
	32	31768	LQG-32
	40	31769	LQG-40
	50	31770	LQG-50
	63	31771	LQG-63

Ordering data – Guide units

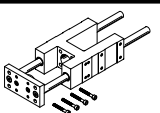
	For ø	Stroke [mm]	With recirculating ball bearing guide		With plain-bearing guide	
			Part no.	Type	Part no.	Type
	8, 10	1 ... 100	35197	FEN-8/10-...-KF	35196	FEN-8/10-...-GF
	12, 16	1 ... 200	33481	FEN-12/16-...-KF	19168	FEN-12/16-...-GF
	20	2 ... 250	33482	FEN-20-...-KF	19169	FEN-20-...-GF
	25	2 ... 250	33483	FEN-25-...-KF	19170	FEN-25-...-GF

Datasheets → Internet: feng

Accessories

Bellows kit DADB



General technical data								
Type DADB-S1-	12	16	20	25	32	40	50	63
Max. stroke range of the cylinder ¹⁾								
DSNU	[mm]	10 ... 200	10 ... 200	10 ... 320	10 ... 500			
Type of mounting		Via threaded pin						
Mounting position		Any						
Media resistance		Dust, chippings, oil, grease, fuel (→ Internet: media resistance)						
Ambient temperature ²⁾	[°C]	-10 ... +80						
Corrosion resistance class CRC ³⁾		3						

1) In conjunction with the bellows kit DADB

2) Note operating range of proximity switches and cylinder

3) Corrosion resistance class CRC 3 to Festo standard FN 940070

High corrosion stress. Outdoor exposure under moderate corrosive conditions. Externally visible parts with primarily functional surface requirements which are in direct contact with a normal industrial environment.

Materials

Sectional view

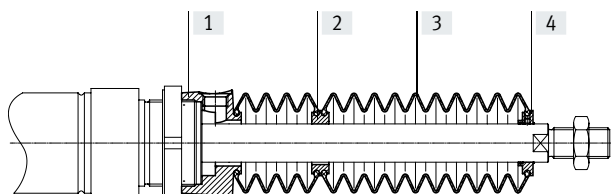

Bellows		
[1]	Connection	Polyamide
[2]	Adapter	Polyamide
[3]	Bellows	NBR
[4]	End piece	Polyamide
-	O-ring	NBR
	Note on materials	RoHS-compliant
	Suitable for the production of lithium-ion batteries	Metals with more than 5% copper, zinc or nickel by mass are excluded from use. Exceptions are nickel in steel, chemically nickel-plated surfaces, printed circuit boards, cables, electrical plug connectors and coils

Accessories

Weights [g]				
Type DADB-S1- Stroke [mm]	12	16	20	25
10 ... 50	7	7	20	19
51 ... 100	9	9	32	31
101 ... 150	13	13	45	44
151 ... 200	16	16	58	57
201 ... 250	–	–	73	72
251 ... 300	–	–	85	84
301 ... 350	–	–	100	98
351 ... 400	–	–	–	109
401 ... 450	–	–	–	124
451 ... 500	–	–	–	136

Type DADB-S1- Stroke [mm]	32	40	50	63
10 ... 50	29	34	55	55
51 ... 125	41	49	75	75
126 ... 175	51	60	89	89
176 ... 250	66	78	113	113
251 ... 300	79	93	131	131
301 ... 350	92	108	149	149
351 ... 375	92	108	151	151
376 ... 425	104	122	169	169
426 ... 475	117	137	187	187
476 ... 500	117	137	189	189

Accessories

Travel speed v as a function of tubing length l



The bellows kit is a leak-free system.

To prevent unwanted media from being drawn in, the supply and exhaust air must be ducted via a pressure compensation hole in the connection part.

The pressure generated in the bellows kit by the positioning motion is primarily defined by the travel speed and tubing length. The recommended tubing length based on the travel speed of the drive can be read from the graph.

Advancing

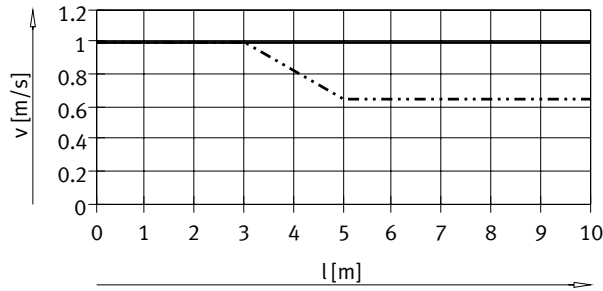

— DSNU-12/16
- · - · - DSNU-20/25

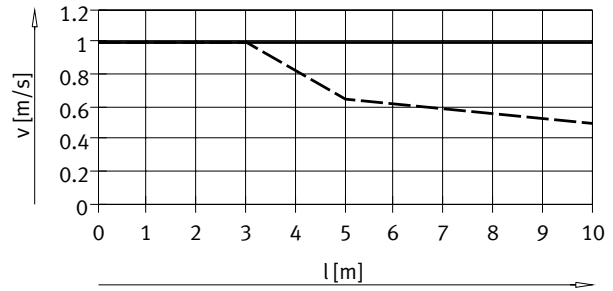

— DSNU-32/50/63
- - - - DSNU-40

Retracting

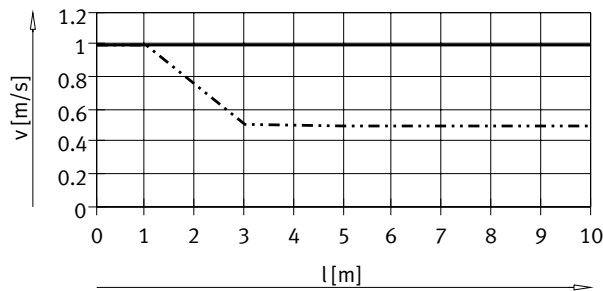

— DSNU-12/16
- · - · - DSNU-20/25

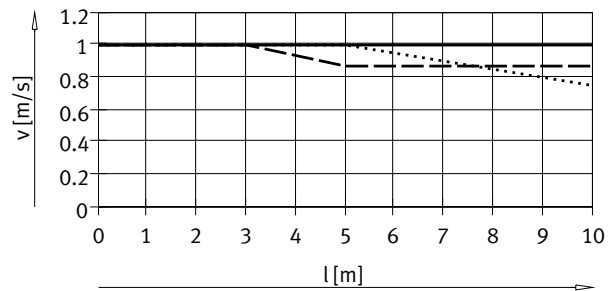

— DSNU-32
- · - · - DSNU-40
- - - - DSNU-50/63

 Note
The push-in fittings in the adjacent table must be used for the pressure compensation hole. Silencers can be used as an alternative. This reduces the travel speed slightly.

Tubing size and push-in fitting for pressure compensation hole			
∅ [mm]	Tubing O.D. [mm]	Push-in fitting	
		Part no.	Type
12, 16, 20, 25	6	★ 153317	QSM-M5-6-I
		578371	NPQH-DK-M5-Q6-P10
		578335	NPQH-D-M5-Q6-P10
		578359	NPQH-D-M5-S6-P10
32, 40	8	★ 186109	QS-G1/8-8-I
		578376	NPQH-DK-G18-Q8-P10
		578362	NPQH-D-G18-S8-P10
50, 63	12	★ 186350	QS-G1/4-12
		578344	NPQH-D-G14-Q12-P10
		578366	NPQH-D-G14-S12-P10

Accessories

Dimensions

Download CAD data → www.festo.com

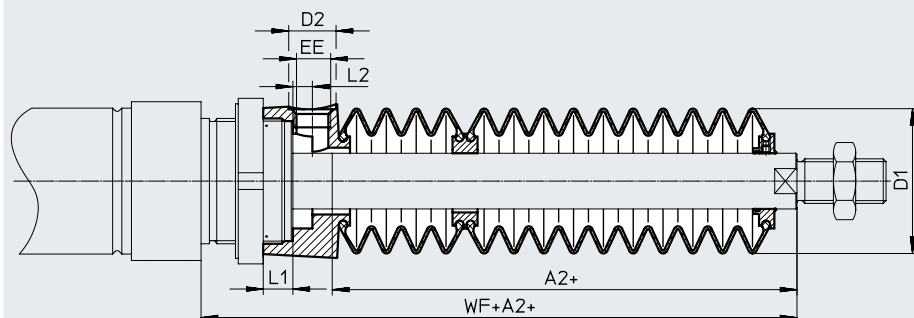

∅ Stroke [mm]	12/16							20						
	A2 ¹⁾	D1 ∅ max.	D2 ∅	EE	L1	L2	WF+A2	A2 ¹⁾	D1 ∅ max.	D2 ∅	EE	L1	L2	WF+A2
10 ... 50	23	22	8.5	M5	5	3.2	45	22	29	8.5	M5	4.2	2.7	46
51 ... 100	34						56	34						58
101 ... 150	48						70	47						71
151 ... 200	59						81	60						84
201 ... 250	–						–	75						99
251 ... 300	–						–	86						110
301 ... 350	–						–	101						125
351 ... 400	–						–	–						–
401 ... 450	–						–	–						–
451 ... 500	–						–	–						–

∅ Stroke [mm]	25						
	A2 ¹⁾	D1 ∅ max.	D2 ∅	EE	L1	L2	WF+A2
10 ... 50	22	29	8.5	M5	4.2	2.7	50
51 ... 100	34						62
101 ... 150	47						75
151 ... 200	60						88
201 ... 250	75						103
251 ... 300	86						114
301 ... 350	101						129
351 ... 400	112						140
401 ... 450	127						155
451 ... 500	138						166

1) The dimension corresponds to the K8 value (extended piston rod) of the drive

Accessories

Dimensions

Download CAD data → www.festo.com

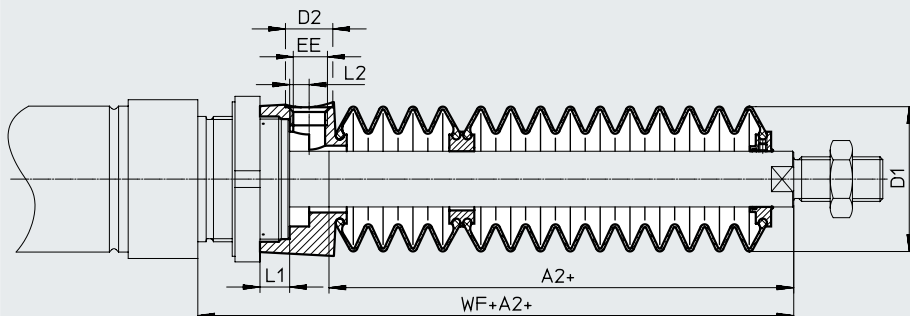

∅ Stroke [mm]	32							40						
	A2 ¹⁾	D1 ∅ max.	D2 ∅	EE	L1	L2	WF+A2	A2 ¹⁾	D1 ∅ max.	D2 ∅	EE	L1	L2	WF+A2
10 ... 50	30	38	14	G1/8	12.9	5.4	64	29	46	14	G1/8	8.1	5.4	68
51 ... 125	48						82	44						83
126 ... 175	63						97	57						96
176 ... 250	82						116	73						112
251 ... 300	97						131	87						126
301 ... 350	113						147	101						140
351 ... 375	115						149	102						141
376 ... 425	131						165	116						155
426 ... 475	147						181	131						170
476 ... 500	149						183	132						171

∅ Stroke [mm]	50/63						
	A2 ¹⁾	D1 ∅ max.	D2 ∅	EE	L1	L2	WF+A2
10 ... 50	30	57	17	G1/4	10.65	7	74/75
51 ... 125	48						92/93
126 ... 175	58						102/103
176 ... 250	77						121/122
251 ... 300	88						132/133
301 ... 350	99						143/144
351 ... 375	106						150/151
376 ... 425	117						161/162
426 ... 475	128						172/173
476 ... 500	135						179/180

1) The dimension corresponds to the K8 value (extended piston rod) of the drive

Accessories

Ordering data – Bellows kit

An extended piston rod (order code K8) is absolutely essential when using a bellows kit → Ordering data – Modular product system.

The necessary dimension for K8 as a function of piston diameter and cylinder stroke as well as the corresponding bellows kit is indicated in the table below:

Order example:

Selected round cylinder:

DSNU-25-320-PPV-A-MQ-...

The dimension for the corresponding K8 value (see table): 101 mm

Complete order reference for round cylinder:

DSNU-25-320-PPV-A-MQ-...-101K8

The corresponding bellows kit:

DADB-S1-25-S301-350

Cylinder data			Bellows kit		
∅	Stroke	Dimension for K8	Part no.	Type	
[mm]	[mm]	[mm]			
12	10 ... 50	23	553391	DADB-S1-12-S10-50	
	51 ... 100	34	553393	DADB-S1-12-S51-100	
	101 ... 150	48	553395	DADB-S1-12-S101-150	
	151 ... 200	59	553397	DADB-S1-12-S151-200	
20	10 ... 50	22	553407	DADB-S1-20-S10-50	
	51 ... 100	34	553409	DADB-S1-20-S51-100	
	101 ... 150	47	553411	DADB-S1-20-S101-150	
	151 ... 200	60	553413	DADB-S1-20-S151-200	
	201 ... 250	75	553415	DADB-S1-20-S201-250	
	251 ... 300	86	553417	DADB-S1-20-S251-300	
	301 ... 320	101	553419	DADB-S1-20-S301-350	
32	10 ... 50	30	553441	DADB-S1-32-S10-50	
	51 ... 125	48	553443	DADB-S1-32-S51-125	
	126 ... 175	63	553445	DADB-S1-32-S126-175	
	176 ... 250	82	553447	DADB-S1-32-S176-250	
	251 ... 300	97	553449	DADB-S1-32-S251-300	
	301 ... 350	113	553451	DADB-S1-32-S301-350	
	351 ... 375	115	553453	DADB-S1-32-S351-375	
	376 ... 425	131	553455	DADB-S1-32-S376-425	
	426 ... 475	147	553457	DADB-S1-32-S426-475	
	476 ... 500	149	553459	DADB-S1-32-S476-500	
50	10 ... 50	30	553481	DADB-S1-50-S10-50	
	51 ... 125	48	553483	DADB-S1-50-S51-125	
	126 ... 175	58	553485	DADB-S1-50-S126-175	
	176 ... 250	77	553487	DADB-S1-50-S176-250	
	251 ... 300	88	553489	DADB-S1-50-S251-300	
	301 ... 350	99	553491	DADB-S1-50-S301-350	
	351 ... 375	106	553493	DADB-S1-50-S351-375	
	376 ... 425	117	553495	DADB-S1-50-S376-425	
	426 ... 475	128	553497	DADB-S1-50-S426-475	
	476 ... 500	135	553499	DADB-S1-50-S476-500	
16	10 ... 50	23	553399	DADB-S1-16-S10-50	
	51 ... 100	34	553401	DADB-S1-16-S51-100	
	101 ... 150	48	553403	DADB-S1-16-S101-150	
	151 ... 200	59	553405	DADB-S1-16-S151-200	
	25	10 ... 50	22	553421	DADB-S1-25-S10-50
		51 ... 100	34	553423	DADB-S1-25-S51-100
		101 ... 150	47	553425	DADB-S1-25-S101-150
		151 ... 200	60	553427	DADB-S1-25-S151-200
		201 ... 250	75	553429	DADB-S1-25-S201-250
		251 ... 300	86	553431	DADB-S1-25-S251-300
301 ... 350		101	553433	DADB-S1-25-S301-350	
351 ... 400		112	553435	DADB-S1-25-S351-400	
401 ... 450		127	553437	DADB-S1-25-S401-450	
451 ... 500		138	553439	DADB-S1-25-S451-500	
40	10 ... 50	29	553461	DADB-S1-40-S10-50	
	51 ... 125	44	553463	DADB-S1-40-S51-125	
	126 ... 175	57	553465	DADB-S1-40-S126-175	
	176 ... 250	73	553467	DADB-S1-40-S176-250	
	251 ... 300	87	553469	DADB-S1-40-S251-300	
	301 ... 350	101	553471	DADB-S1-40-S301-350	
	351 ... 375	102	553473	DADB-S1-40-S351-375	
	376 ... 425	116	553475	DADB-S1-40-S376-425	
	426 ... 475	131	553477	DADB-S1-40-S426-475	
	476 ... 500	132	553479	DADB-S1-40-S476-500	
63	10 ... 50	30	553501	DADB-S1-63-S10-50	
	51 ... 125	48	553503	DADB-S1-63-S51-125	
	126 ... 175	58	553505	DADB-S1-63-S126-175	
	176 ... 250	77	553507	DADB-S1-63-S176-250	
	251 ... 300	88	553509	DADB-S1-63-S251-300	
	301 ... 350	99	553511	DADB-S1-63-S301-350	
	351 ... 375	106	553513	DADB-S1-63-S351-375	
	376 ... 425	117	553515	DADB-S1-63-S376-425	
	426 ... 475	128	553517	DADB-S1-63-S426-475	
	476 ... 500	135	553519	DADB-S1-63-S476-500	

Accessories

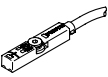
Ordering data – Proximity switch for T-slot, magneto-resistive						Datasheets → Internet: smt
Type of mounting	Switching output	Electrical connection	Cable length [m]	Part no.	Type	
N/O						
	Inserted in the slot from above, flush with the cylinder profile, short design	PNP	Cable, 3-wire	2.5	★ 574335	SMT-8M-A-PS-24V-E-2,5-OE
			Cable, 2-wire	5	★ 8165237	SMT-8M-A-ZS-24V-E-5,0-OE
			Plug M8x1, 3-pin	0.3	★ 574334	SMT-8M-A-PS-24V-E-0,3-M8D
		NPN	Cable, 3-wire	2.5	★ 574338	SMT-8M-A-NS-24V-E-2,5-OE
			Plug M8x1, 3-pin	0.3	★ 574339	SMT-8M-A-NS-24V-E-0,3-M8D

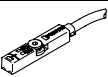
Ordering data – Proximity switch for T-slot, magneto-resistive						Datasheets → Internet: crsmt
Type of mounting	Switching output	Electrical connection	Cable length [m]	Part no.	Type	
N/O						
	Inserted in the slot from above, flush with the cylinder profile	PNP	Cable, 3-wire	5.0	574380	CRSMT-8M-PS-24V-K-5,0-OE
			Cable, 3-wire	10.0	574381	CRSMT-8M-PS-24V-K-10,0-OE
			Plug M8x1, 3-pin	0.3	574383	CRSMT-8M-PS-24V-K-0,3-M8D
			Plug M12x1, 3-pin	0.3	574382	CRSMT-8M-PS-24V-K-0,3-M12

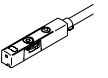
Ordering data – Proximity switch for T-slot, Magnetic Hall						Datasheets → Internet: sdbt
Type of mounting	Switching output	Electrical connection	Cable length [m]	Part no.	Type	
N/O or N/C contact, switchable						
	Inserted in the slot from above, flush with the cylinder profile, short design	PNP, switchable to NPN	Plug M8x1, 3-pin	0.3	★ 8059120	SDBT-MSX-1L-PU-E-0.3-N-M8
			Cable, 3-wire	2.5	★ 8059121	SDBT-MSX-1L-PU-E-2.5-N-LE
		NPN, switchable to NPN	Plug M8x1, 3-pin	0.3	★ 8059123	SDBT-MSX-1L-NU-E-0.3-N-M8
			Cable, 3-wire	2.5	★ 8059124	SDBT-MSX-1L-NU-E-2.5-N-LE

Ordering data – Mounting kits for proximity switch				Datasheets → Internet: smbr
Designation	For ø	Part no.	Type	
Mounting kit SMBR-8				
	8	175091	SMBR-8-8	
	10	175092	SMBR-8-10	
	12	★ 175093	SMBR-8-12	
	16	★ 175094	SMBR-8-16	
	20	★ 175095	SMBR-8-20	
	25	★ 175096	SMBR-8-25	
	32	175097	SMBR-8-32	
	40	175098	SMBR-8-40	
	50	175099	SMBR-8-50	
63	175100	SMBR-8-63		

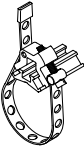
Ordering data – Mounting kits for proximity switch, temperature range S6				Datasheets → Internet: smbr
Designation	For ø	Part no.	Type	
Mounting kit SMBR-8				
	8 ... 63	538937	SMBR-8-8/100-S6	

Accessories

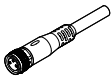
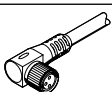
Ordering data – Connecting cables				Datasheets → Internet: nebu	
	Electrical connection, left	Electrical connection, right	Cable length [m]	Part no.	Type
	Straight socket, M8x1, 3-pin	Cable, open end, 3-wire	2.5	★ 541333	NEBU-M8G3-K-2.5-LE3
			5	★ 541334	NEBU-M8G3-K-5-LE3
	Straight socket, M12x1, 5-pin	Cable, open end, 3-wire	2.5	★ 541363	NEBU-M12G5-K-2.5-LE3
			5	★ 541364	NEBU-M12G5-K-5-LE3
	Angled socket, M8x1, 3-pin	Cable, open end, 3-wire	2.5	★ 541338	NEBU-M8W3-K-2.5-LE3
			5	★ 541341	NEBU-M8W3-K-5-LE3
	Angled socket, M12x1, 5-pin	Cable, open end, 3-wire	2.5	★ 541367	NEBU-M12W5-K-2.5-LE3
			5	★ 541370	NEBU-M12W5-K-5-LE3

Position transmitter

The position transmitter continuously senses the position of the piston.

It has an analogue output with an output signal relative to the piston position.

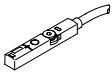
Ordering data – Position transmitter for T-slot							Datasheets → Internet: sdas	
	Position measuring range	Description	Type of mounting	Electrical connection	Cable length [m]	Part no.	Type	
	≤ 52	Choice of two operating modes: • two adjustable switching outputs • IO-Link	Inserted in the slot from above	Plug M8x1, 4-pin, lengthwise	0.3	8063974	SDAS-MHS-M40-1L-PNLK-PN-E-0.3-M8	

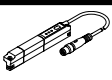
Ordering data – Position transmitter for T-slot							Datasheets → Internet: sdat	
	Position measuring range	Analogue output		Type of mounting	Electrical connection	Cable length [m]	Part no.	Type
		[V]	[mA]					
	0 ... 50	–	4 ... 20	Inserted in the slot from above	Plug M8x1, 4-pin, lengthwise	0.3	1531265	SDAT-MHS-M50-1L-SA-E-0.3-M8
	0 ... 80						1531266	SDAT-MHS-M80-1L-SA-E-0.3-M8
	0 ... 100						1531267	SDAT-MHS-M100-1L-SA-E-0.3-M8
	0 ... 125						1531268	SDAT-MHS-M125-1L-SA-E-0.3-M8
	0 ... 160						1531269	SDAT-MHS-M160-1L-SA-E-0.3-M8

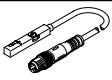
Ordering data – Position transmitter for T-slot							Datasheets → Internet: smat	
	Position measuring range	Analogue output		Type of mounting	Electrical connection	Cable length [m]	Part no.	Type
		[V]	[mA]					
	0 ... 40	0 ... 10	–	Inserted in the slot from above	Plug M8x1, 4-pin, lengthwise	0.3	553744	SMAT-8M-U-E-0,3-M8D

Ordering data – Mounting kits for position transmitter				Datasheets → Internet: smbr	
Designation	For Ø	Part no.	Type		
Mounting kit SMBR-8					
	8	175091	SMBR-8-8		
	10	175092	SMBR-8-10		
	12	★ 175093	SMBR-8-12		
	16	★ 175094	SMBR-8-16		
	20	★ 175095	SMBR-8-20		
	25	★ 175096	SMBR-8-25		
	32	175097	SMBR-8-32		
	40	175098	SMBR-8-40		
	50	175099	SMBR-8-50		
63	175100	SMBR-8-63			

Accessories

Ordering data – Mounting kits for position transmitter, temperature range S6

Datasheets → Internet: smbr

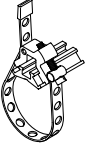
Designation	For Ø	Part no.	Type
Mounting kit SMBR-8			
	8 ... 63	538937	SMBR-8-8/100-S6

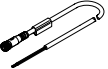
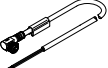

Ordering data – Connecting cables

Datasheets → Internet: nebu

	Electrical connection, left	Electrical connection, right	Cable length [m]	Part no.	Type
	Straight socket, M8x1, 3-pin	Cable, open end, 4-wire	2.5	541342	NEBU-M8G4-K-2.5-LE4
			5	541343	NEBU-M8G4-K-5-LE4
	Angled socket, M8x1, 3-pin	Cable, open end, 4-wire	2.5	541344	NEBU-M8W4-K-2.5-LE4
			5	541345	NEBU-M8W4-K-5-LE4

Ordering data – One-way flow control valves

Datasheets → Internet: grl

	Connection Thread	For tubing O.D.	Material	Part no.	Type		
For exhaust air							
	M5	3	Metal design	★ 193137	GRLA-M5-QS-3-D		
		4		★ 193138	GRLA-M5-QS-4-D		
		6		★ 193139	GRLA-M5-QS-6-D		
	G1/8	3		★ 193142	GRLA-1/8-QS-3-D		
		4		★ 193143	GRLA-1/8-QS-4-D		
		6		★ 193144	GRLA-1/8-QS-6-D		
		8		★ 193145	GRLA-1/8-QS-8-D		
	G1/4	6		★ 193146	GRLA-1/4-QS-6-D		
		8		★ 193147	GRLA-1/4-QS-8-D		
		10		★ 193148	GRLA-1/4-QS-10-D		
	G3/8	6		★ 193149	GRLA-3/8-QS-6-D		
		8		★ 193150	GRLA-3/8-QS-8-D		
		10		★ 193151	GRLA-3/8-QS-10-D		
	For supply air						
		M5		3	Metal design	★ 193153	GRLZ-M5-QS-3-D
4			★ 193154	GRLZ-M5-QS-4-D			
6			★ 193155	GRLZ-M5-QS-6-D			
G1/8		3	★ 193156	GRLZ-1/8-QS-3-D			
		4	★ 193157	GRLZ-1/8-QS-4-D			
		6	★ 193158	GRLZ-1/8-QS-6-D			
		8	★ 193159	GRLZ-1/8-QS-8-D			